



Auto Anchor



AutoAnchor 560 V2

OWNER'S MANUAL

AutoAnchor 560 Owner's Manual

TABLE OF CONTENTS

Part 1	Important Information	1
Part 2	Installation	3
Part 3	Set Up	13
Part 4	Operation	20
Part 5	Maintenance	25
Part 6	Troubleshooting	25
Index		43

To the best of our knowledge the information in this manual was correct at the time of printing. However, the AutoAnchor products are continuously being reviewed and improved and product specifications may be changed without notice. The latest product specifications may not be reflected in this version of the manual. The documentation relating to the AutoAnchor products is created in the English language and may be translated from English to another language. In the event of any conflict between translated documents, the English language version will be the official version.

AutoAnchor documents are available on www.autoanchor.co.nz

PART 1 IMPORTANT INFORMATION

READ BEFORE INSTALLING OR USING THE AUTOANCHOR

- The AA560 should only be installed by a qualified marine electrician. Do not attempt to install the AA560 unless you are suitably qualified.
- This manual supports the use of the AA560 only. The appropriate manufacturer's instructions must be followed for the installation and use of the windlass it is set up to control.
- There must be an alternative method available to operate the windlass.
- The AA560 can be fitted to most vertical windlasses. A horizontal windlass may require a sensor holder or a custom designed sensor which is not included in the standard pack. Check with your supplier or the AutoAnchor manufacturer.
- The AA560 must be fitted to a windlass with a dual direction control box or solenoid pack.
- Information for installation and operation of the AA560 is supplied, including pre-set windlass profile lists, wiring diagrams, the Owner's Manual and the Quick User Guide. **All documents must be left on board for the owner.**
- Non compliance with the instructions could impair the windlass and the AA560 operation, and could result in personal injury and/or damage to the boat.
- Non compliance with the instructions will negate the manufacturer's warranty.
- The AA560 manufacturer and supplier accept no liability for personal injury or property damage resulting from failure to follow the installation and operation instructions or the use of the AA560 in a way that may cause accidents or damage or that may violate the law.
- All the technical and cable specifications must be checked and adhered to.
- Wiring diagrams must be followed without modification.
- Before use the AA560 must be correctly set up for the windlass it is to control and tested in a safe environment. The AA560 will not count correctly if the windlass selection is wrong or the windlass is not standard (eg it is installed with a different chainwheel or motor).
- All installations must be carried out in accordance with USCG, ABYC, NMMA and BMEA requirements.
- When this product reaches the end of its useful life it must be disposed of in accordance with local regulations.

TECHNICAL SPECIFICATIONS AA560

Power Supply	12V/24V DC
Maximum Voltage	30V DC
Current Consumption	70mA
Output Maximum Current Draw	12V DC: 4A 24V DC: 4A
Output Minimum Current Draw	12V DC: 10mA 24V DC: 20mA When connecting to a solid state switching or other low current windlass drive eg a PLC or AC variable frequency drive a dummy resistor load (Part #9515) may be required.
IP Rating	IP67 from the front provided the unit is mounted so the back is protected from moisture.
Operating Temperature Range	23°F to 140°F (-5°C to 60°C)
Sensor	Compatible with all AutoAnchor sensors, reed switches and some proximity switches.
Rode - Chain Only	Stainless or galvanised steel.
Rode - Rope and Chain	Must have a minimum of 10ft (3 m) of chain. Chain must be galvanised steel. Rope should be a good quality, nylon anchor rope. Type 66 or equivalent.
DC windlasses require a dual direction solenoid	

ELECTROMAGNETIC COMPATIBILITY (EMC)

FCC Information:

This device complies with CFR47 Part 15 of FCC Rules for Class B equipment.

ESTI Information (CE):

This device meets the relevant standards set out in European Standard EN 60945:2002 for maritime navigation and radio communication equipment and systems. These standards are intended to provide reasonable protection against interference by other emission generating products on the boat. Compliance with these standards is no guarantee that interference will not occur in a particular installation. The installation instructions must be followed to minimise the potential for interference.

Note: If shielded cable is not used for the sensor connections this will compromise the EMC and may invalidate the warranty.

The AA560 console must be installed at least 3ft (1m) away from any transmission equipment or cables carrying radio signals eg VHF radios, cables and antennas or radar antennas; and at least 6ft (2m) away from any SSB equipment. AA560 cables must be installed at least 1.5ft (500mm) away from such items.

PART 2 INSTALLATION

2.1 MAGNET AND SENSOR INSTALLATION

PLEASE READ BEFORE COMMENCING INSTALLATION

Correct magnet and sensor installation is critical for successful AutoAnchor operation.

The AutoAnchor can be installed on vertical windlasses, drum winches and most horizontal windlasses. Installation differs depending on the windlass type and on the rode (all-chain or rope and chain). **Please follow the instructions for your windlass and rode.** If it is not possible to comply with these instructions please check with the AutoAnchor manufacturer or your supplier for other options or if you are not sure how to proceed.

See www.autoanchor.co.nz for contact information.

2.1.1 MAGNET INSTALLATION OVERVIEW

Check before starting: Your chainwheel may be prefitted with a magnet or predrilled ready for you to fit the magnet.

Magnet Polarity: Not relevant when using the grey AA sensor (#9067) or a reed switch sensor. If retrofitting, using the black AA sensor (#9008) the south pole (marked side) of the magnet must face the sensor.

Magnet Seal: Insert the magnet into the hole and cover it with a minimum of 1mm of epoxy to protect it against corrosion. See Fig 1 on page 6.

Magnet Size and Position: Refer to the instructions for your specific windlass type.

2.1.2 SENSOR INSTALLATION OVERVIEW

Vertical Windlasses: The sensor is fitted in the deckplate. Some deckplates are predrilled for the sensor. Others have a dimple or mark to show where the sensor should be fitted. If the windlass is not factory drilled, drill a hole 10.3mm (13/32") diameter through the windlass deckplate. See the instructions for your specific windlass type.

Horizontal Windlasses: **Sometimes it is not possible to fit the sensor to a horizontal windlass or it may need to be fitted by the windlass manufacturer. Before starting check with the AutoAnchor manufacturer or supplier that it is possible to fit the sensor to your windlass. You may need a special fitting.**

Drilling the Deck: Before drilling into the deck, ensure there is nothing below the deck that could be damaged and that any hole you drill will not weaken the boat's structure. Drill a hole 10.3mm (13/32") diameter through the deck. Ensure this hole is directly in line with the sensor hole in the deckplate.

Fitting the Sensor: Do not force the sensor into the hole. Hammering the sensor head can damage the internal electronics. Ensure the sensor head is positioned so that it will not be hit by the chainwheel during windlass operation and that it is at least 300mm (1ft) away from the battery and motor cables. Secure the sensor using a good quality neutral cure silicone or a strong adhesive eg. Sikaflex 291 or 3M 5200.

2.1.3 PLUG AND PLAY SENSOR CABLE

The AutoAnchor plug and play sensor extension cable is 2 core tinned shielded cable. It must be used to connect the sensor to the console unit. This cable is shielded and ensures the product meets the EMC requirements.

Ensure the connectors are firmly screwed together.

The warranty does not apply if the sensor cable plugs are removed.

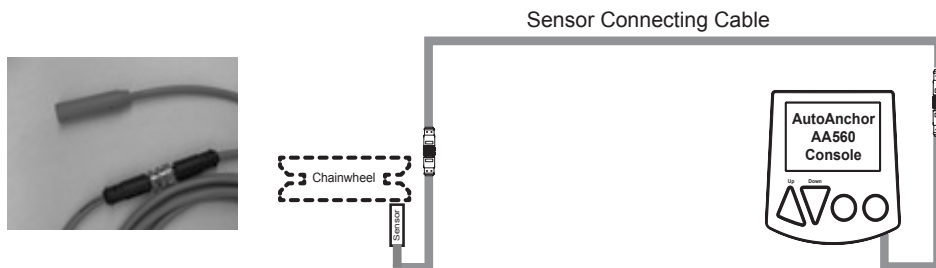

The sensor cable and the console sensor cable are fitted with female plugs. Sensor connecting cable with a male plug at each end is available in the following lengths:

6.5 m	(21.33 ft)	Part #9500
10 m	(32.81 ft)	Part #9501
15 m	(49.21 ft)	Part #9502
20 m	(66.62 ft)	Part #9503
25 m	(82 ft)	Part #9504
35 m	(114.83 ft)	Part #9514

Connecting 2 cables together:



If you need to extend the cable length - 2 cables can be joined together using Part #9510 Gender changer.

Field Connectors



Part #9507 Male Field Connector
Part #9508 Female Field Connector

If there is no plug on the sensor or console cable attach the AA field connector to the wires and use the connecting cable as above.

Dual Installation

Use the T junction connector Part #9506 and the 2m (Male/Female) extension cable Part #9505.

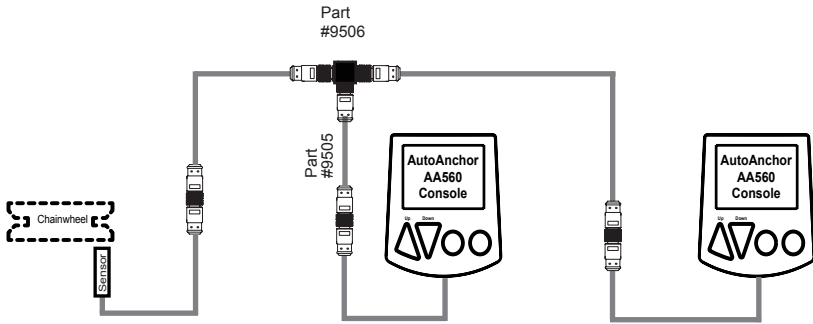

2.1.4 REED SWITCH SENSORS

Some windlasses are supplied pre-fitted with a reed switch sensor. Reed switch sensors must have a 10mm x 8mm magnet (#9061) and the gap between the reed switch sensor and the magnet must be a minimum of 3mm and a maximum of 5mm. This sensor requires a field connector.

The AutoAnchor will operate with a reed switch sensor for all-chain rode. If using rope/chain rode the reed switch sensor provides a reasonably accurate count of rode deployed but on retrieval the display may be incorrect because it cannot allow for the stretch in the rope.

For an accurate rope and chain count, the reed switch sensor should be replaced with the AA grey sensor (#9067).

2.1.5 PLUG AND PLAY SENSOR TUNING

When the AutoAnchor is completely installed the sensor must be tuned. See the instructions on page 21.

2.1.6 INSTALLATION VERTICAL WINDLASS - CHAIN ONLY

Refer to the Overview Notes on page 3 before starting installation.

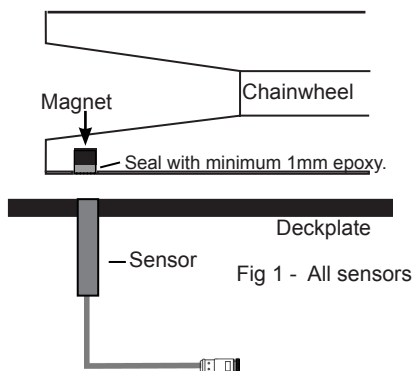

Note: If it is not possible to align the sensor and magnet exactly the AA grey sensor may be fitted up to 20mm out of alignment. The AA black sensor and the reed switch sensor must be directly aligned.

Magnet Size: Standard size is 10mm x 8mm (#9061). This may be replaced with the smaller 6mm x 4mm (#9009) magnet if required for your windlass.

Magnet Fit: Drill a hole 10.3mm (13/32”) diameter and 9.5mm (3/8”) deep to fit the magnet in the underside of a spoke in the bottom of the chainwheel. Cover the magnet with a minimum of 1 mm epoxy. The magnet must be aligned with the sensor. See Fig 1.

Sensor Position: The AA black sensor and the reed switch sensor must be fitted directly in line with the magnet in the chainwheel. See Fig 1 above. The AA grey sensor may be fitted up to 20mm out of alignment. The gap between the sensor and magnet must be as per the table below.

Gap Between the Sensor and Magnet:

Sensor	Magnet Size	Gap
AA Grey Sensor #9067	6mm x 4mm	Minimum 3mm - Maximum 30mm
AA Grey Sensor #9067	10mm x 8mm	Minimum 3mm - Maximum 50mm
AA Black Sensor #9008	All Magnets	Minimum 3mm - Maximum 8mm
Reed Switch Sensor	10mm x 8mm	Minimum 3mm - Maximum 5mm

Sensor Connection: The AutoAnchor plug and play sensor extension cable must be used to connect the sensor to the console unit. Ensure the connectors are firmly screwed together. See the information on page 4.

Loose cable should be tied in place with cable ties and kept clear of chain.

2.1.7 INSTALLATION VERTICAL WINDLASS - ROPE & CHAIN

Refer to the Overview Notes on page 3 before starting installation.

For an accurate rope and chain count, the rode must run between the sensor and magnet. If your windlass is prefitted with a magnet in the bottom of the chainwheel you need to remove it and fit a new magnet in the top of the chainwheel. Refer to Figs 2-4.

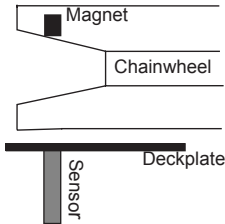

Fig 2

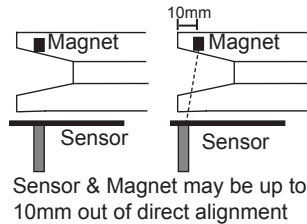

Fig 3

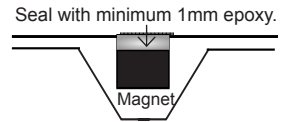

Fig 4

Magnet Size: 10mm X 8mm magnet (#9061). An 8mm x 6mm magnet (#9052) may be used on smaller windlasses. Check with your supplier.

Magnet Fit: Some windlasses are predrilled and others need a special fit. Please check with your supplier. The usual fit is as follows: Drill a hole 10.3mm (13/32") diameter and 9.5mm (3/8") deep into a spoke in the top of the chainwheel. Cover the magnet with a minimum of 1mm epoxy. The magnet and sensor must be aligned so that the anchor rode passes between them. (See Figs 2 & 3).

Sensor Position: The sensor must be fitted into the deckplate within the sensor position range at the stern end of the windlass (See Fig 5). It must also be aligned with the magnet so that the rode passes between the sensor and the magnet. The centre of the magnet and the centre of the sensor may be up to 10mm out of direct alignment. (See Fig 3). The gap between the sensor and magnet must be as per the table below.

Gap Between the Sensor and Magnet

Sensor	Magnet Size	Gap
AA Grey Sensor #9067	8mm x 6mm	Minimum 30mm - Maximum 44mm
AA Grey Sensor #9067	10mm x 8mm	Minimum 35mm - Maximum 50mm

Sensor Position Rope & Chain Vertical Windlasses

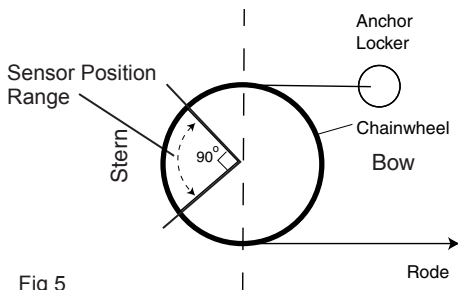

Fig 5

Sensor Connection: The AutoAnchor plug and play sensor extension cable must be used to connect the sensor to the console unit. Ensure the connectors are firmly screwed together. See the information on page 4.
Loose cable should be tied in place with cable ties and kept clear of chain.

2.1.8 INSTALLATION HORIZONTAL WINDLASS - CHAIN ONLY

Refer to the Overview Notes on page 3 before starting installation. It is not possible to set out a single installation method for horizontal windlasses. The sensor may be fitted inside the windlass or you may need a sensor holder (Part # AA9110). See Fig 6 below. Often the sensor and magnet can only be fitted by the windlass manufacturer.

Magnet & Sensor Fitting for Chain Only Horizontal Windlasses

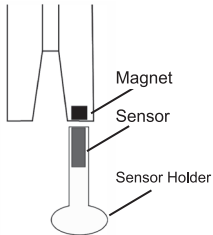

Fig 6
Magnet in rim of chainwheel and standard sensor in sensor holder screwed to the deck

Magnet Size: 6mm x 4mm magnet (#9009).

Magnet Fit: If your windlass is not predrilled drill a hole 6.5mm (1/4") diameter and 5mm (3/16") deep in the edge of the chainwheel. Cover the magnet with a minimum of 1mm epoxy.

Sensor Position: The AutoAnchor sensor may be fitted using a sensor holder fixed to the deck to sit under the chainwheel (See Fig 6). The AutoAnchor sensor holder (#9110) is not included in the standard kit. Check with your supplier if you need this. The AA black sensor and the reed switch sensor must be fitted directly in line with the magnet in the chainwheel. The AA grey sensor may be fitted up to 20mm out of alignment. The gap between the sensor and magnet must be as per the table below.

Gap Between the Sensor and Magnet:

Sensor	Magnet Size	Gap
AA Grey Sensor #9067	6mm x 4mm	Minimum 3mm - Maximum 30mm
AA Grey Sensor #9067	10mm x 8mm	Minimum 3mm - Maximum 50mm
AA Black Sensor #9008	All Magnets	Minimum 3mm - Maximum 8mm
Reed Switch Sensor	10mm x 8mm	Minimum 3mm - Maximum 5mm

Sensor Connection: The AutoAnchor plug and play sensor extension cable must be used to connect the sensor to the console unit. Ensure the connectors are firmly screwed together. See the information on page 4.

Loose cable should be tied in place with cable ties and kept clear of chain.

2.1.9 INSTALLATION HORIZONTAL WINDLASS - ROPE & CHAIN

Before starting check with the AutoAnchor manufacturer, or supplier, that it is possible to fit the sensor and magnet to your horizontal windlass.

For an accurate rope count the rode must run between the sensor and magnet. On a horizontal windlass the magnet and sensor must be fitted by the windlass manufacturer.

If it is not possible to have the sensor and magnet fitted to achieve this you can use the chain only horizontal windlass installation above. **This provides an accurate count of rode deployed but during retrieval the display may be incorrect because it cannot allow for the stretch in the rope.**

2.1.10 INSTALLATION DRUM WINCHES

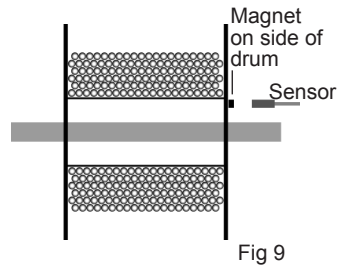
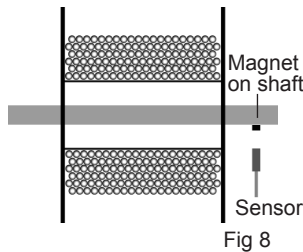
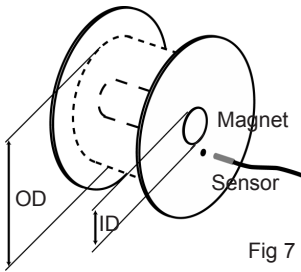

Gap Between the Sensor and Magnet:

Minimum 5mm and maximum 40mm.

The magnet and sensor must be fitted so that the gap remains consistent as the winch turns.

Magnet Installation:

Size: 10mm x 8mm magnet (#9061).

The magnet can be mounted on the main shaft or on the side of the drum. See Figs 8 and 9. If mounted on the side of the drum, position it close to the inside to reduce the peripheral speed of the magnet. Fix the magnet into position with epoxy ensuring it is completely sealed to prevent corrosion.

Sensor Installation

The Grey 3 wire AutoAnchor sensor (#9067) is recommended but a proximity sensor may be used. Every installation is different so this manual can provide guidelines only. The AA sensor holder #9110, or a customised sensor holder, will be required to ensure the sensor remains in position and the gap is consistent between the sensor and magnet during operation.

Sensor Connection: The AutoAnchor plug and play sensor extension cable must be used to connect the sensor to the console unit. Ensure the connectors are firmly screwed together. See the information on page 4.

Loose cable should be tied in place with cable ties and kept clear of chain.

For drum winch set up and operation, refer to page 19.

2.2 CONSOLE INSTALLATION

Choose a position where the operator will be able to see the anchor and windlass when using the AA560.

Mount on a flat surface at least 3ft (1m) away from any equipment or cables carrying radio signals eg VHF radios, cables and antennas or radar antenna and at least 6ft (2m) away from any SSB equipment. The front of the console is waterproof but the cable boot on the back is designed to breathe. Mount the console so that the back is protected from moisture. Refer to the drilling template to drill the 4 holes to mount the console. Do not use sealer or glue. The rubber grommets will seal the unit. Do not use metal studs, nylon bolts are supplied. These should be hand tightened only.

2.2.1 MULTIPLE CONSOLE INSTALLATION

Up to 3 AA560 consoles can be installed to provide multiple control stations. The AA560 can also be installed with other windlass control stations eg foot switches, remote controls and other AutoAnchor products. T-adapters and 2m extension cables are available for multiple installations. Refer to the wiring diagrams and pages 4 and 5 for details. If you are uncertain how to proceed contact your supplier.

2.3 POWER SUPPLY



THE POWER SUPPLY MUST BE DISCONNECTED WHEN INSTALLING, CONNECTING OR CHANGING THE WIRING

12V or 24V DC power supply is required.

Check battery polarity before connecting power.

Refer to the windlass manufacturer's specifications for fuse/breaker, isolator and main power cable specifications. Ensure any fuse/breaker on the control circuit has a rating applicable to the current loads connected to the outputs. (AA560 Output maximum is 4 Amps). An additional isolating switch should be installed for controls if the main breaker or isolator is not readily accessible from the helm.

Multiple battery bank negative terminals must be permanently connected together to become the common negative return (ground).

Power supply to the AA560 must be from the windlass control circuit, along with all other windlass controls eg. toggle switch, remote switches, deck switches, other AutoAnchor devices. **Power supply must not be from the motor positive near the windlass.**

2.4 VOLTAGE LEVELS

Neither the windlass nor the AutoAnchor will operate with insufficient power. (See minimum voltages below). Batteries must be properly maintained and charged and all connections and wires must be of good quality and the correct gauge to prevent voltage drop.

Minimum Voltage Required	12V DC System	24V DC System
Minimum voltage required to start windlass operation.	10V DC	20V DC
If the windlass is already operating, this is the minimum voltage required to continue operating.	6V DC	12V DC

2.5 WIRING

CABLE SPECIFICATIONS	
All battery and motor cables must be ring type, insulated to prevent short circuits and installed no closer than 1ft (300mm) away from the sensor head.	
Total Length	Cable Size
Cable from AA560 to the Power Supply and Solenoids	
Less than 10m (33ft)	1.5mm ² (AWG16)
10m (33ft) - 20m (66ft)	2.0mm ² (AWG14)
20m (66ft) - 40m (132ft)	3.0mm ² (AWG12)
Cable from Motor Load Wires	
Up to 30.5m (100ft)	1.0mm ² (AWG18)

Interlock protection is included in the system. Do not fit diodes or interlock devices to windlass outputs as these will prevent the system from operating correctly.

All main power conductors and terminations are to be installed according to the windlass manufacturer's specifications. Seal terminals against moisture by spraying with CRC [3013] Soft Seal or CRC [2043] Plasticoat 70. Insulation must be used to protect all terminals.

To reduce the potential for interference all cables must be located at least 1.5ft (500mm) away from any equipment or cables carrying radio signals eg VHF or SSB radios, cables and antennas or radar antennas.

Do not leave cables hanging loose, they must be tied in place with cable ties.

2.5.1 MOTOR LOAD WIRES (BROWN AND WHITE) FOR ROPE & CHAIN

All-chain Counting: If the AA560 is fitted to an **all-chain windlass** the brown and white wires are not required.

Rope & Chain Counting: The brown and white wires must be connected for rope & chain counting. These wires are connected direct to the windlass motor terminals to measure the load on the motor. **A 1000 Ohm resistor must be fitted near the motor terminal** for short circuit protection. The motor load terminators supplied in the kit have motor terminal connectors with a 1000 Ohm resistor prefitted.

2.5.2 MULTIPLE AUTOANCHOR INSTALLATIONS

It is important when wiring multiple AutoAnchor products that potential differences do not occur along the ground connection. This can cause incorrect counting. Ensure consoles are star grounded, and that there are no other high current paths between consoles. **All wiring for multiple installations is run in parallel.** Refer to wiring diagrams for further details.

2.5.3 CONNECTION TO LOW CURRENT WINDLASS DRIVES

When connecting to solid state switching or other low current windlass drives eg PLC or AC variable frequency drives a dummy resistor load (Part # 9083) may be required to provide sufficient loading and to meet EMC and safety considerations. The resistor pack should be installed close to the windlass control **not on the AA560.**

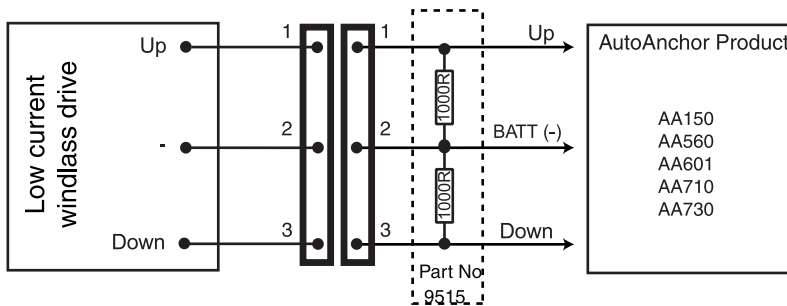

2.5.4 PLUG & PLAY SENSOR CONNECTIONS

Refer to page 4 for plug and play sensor cable information.







2.5.5 WIRING DIAGRAMS FOR AA560

Wiring diagrams are included in the kit. Please refer to them for wiring detail.

These diagrams and installation help are available on www.autoanchor.co.nz

PART 3 SET UP

3.1 USING THE AUTOANCHOR BUTTONS

-  Scroll: Menu/Numbers/Up/Down.
-  Mode/Select/Enter/Save.
-  On/Off/Escape or Back.
-  Hold together to access the Set up menu.
-  Hold for 2 seconds to disable the lock.
-  Hold for 2 seconds to return the AutoAnchor to the idle state.

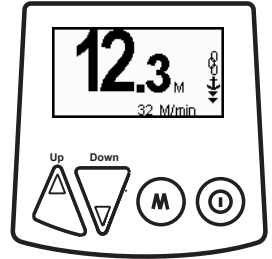

3.2 SET UP MENU OVERVIEW

The AutoAnchor must be turned off to access the Set up menu.

Hold  +  together to display the Set up menu.

Use  to scroll through the menu.

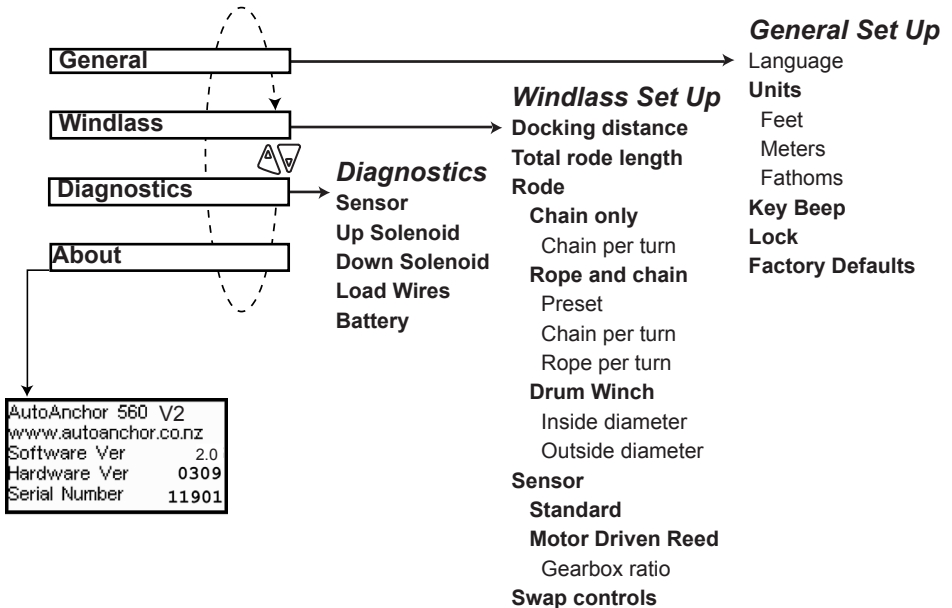

3.3 GENERAL SET UP

To Access General Set Up

- ⊖ Turn the AutoAnchor Off.
- Ⓜ+⊖ Hold together to display the Set Up menu.
- Ⓜ Select General.

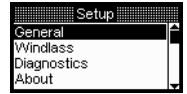

To Exit General Set Up

- ⊖ Exit to the Set up menu or hold for 2 seconds to exit to the start screen.

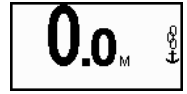

Set Language

- Ⓜ Select Language.
- ⓂⓂ Scroll to the preferred language.
- Ⓜ Save.
- ⊖ Return to General Menu.

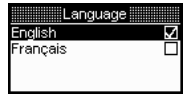

Set Units

- Ⓜ Select units.
- ⓂⓂ Scroll to meters, feet or fathoms.
- Ⓜ Save.
- ⊖ Return to General Menu.

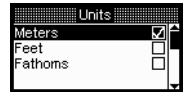

Set Key Beep

- ⓂⓂ Scroll to key beep.
- Ⓜ Save key beep on or off.

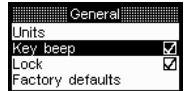

Set Lock - For safety we recommend the lock be left on.

- ⓂⓂ Scroll to lock.
- Ⓜ Save lock on or off.

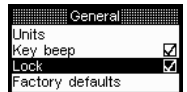

3.4 FACTORY DEFAULTS



Resetting the Factory Defaults clears all programmed settings and logs.

To Reset Factory Defaults:



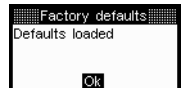
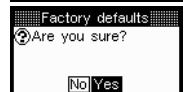
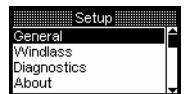

- ⊖ Turn the AutoAnchor off.
- Ⓜ+⊖ Hold together to access the Set up menu.
- Ⓜ Select General.
- Ⓜ Select Factory defaults.
- ⓂⓂ Select No/Yes.
- Ⓜ **Yes** - Apply the factory reset. The AutoAnchor will turn off.
- Re-enter all your Settings.**
- No** - Return to the General menu.
- ⊖ Hold the On/Off button down for 2 seconds to return the AutoAnchor to the start screen.



3.5 WINDLASS SET UP

For accurate counting you must set up the AutoAnchor with information for your windlass. Record the settings for future reference.

3.5.1 To Access Windlass Set up



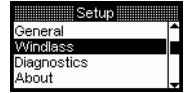

-  Turn the AutoAnchor Off.
-  Hold together to access the Set up menu.
-  Scroll to Windlass.
-  Select Windlass.



3.5.2 Set Docking Distance

Setting:

Default = 1.5m or 4ft. Minimum setting = 1m or 3.3ft.
Note: During retrieval the windlass stops at the docking distance.



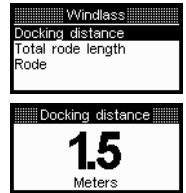

-  Scroll to Docking distance.
-  Select docking distance.
-  Increase or decrease the docking distance.
-  Save and return to Windlass Setup.



3.5.3 Set Total Rode Length

Setting:

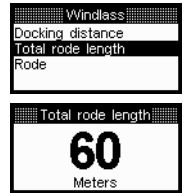

Add total length of chain plus total length of rope.
Default = 60m or 196ft. Minimum setting = 10m (33ft).
or OFF to operate as a counter only.

-  Scroll to Total rode length.
-  Select Total rode length.
-  Increase or decrease the value in meters or feet.
-  Save and return to Windlass Set up.



3.5.4 Set Rode

Setting:

-  Scroll to Rode.
-  Select Rode.
-  Select Chain only or Rope and chain and follow the instructions below to enter the settings for the rode selected.

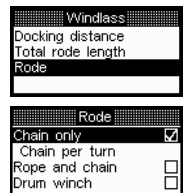





3.6 CHAIN ONLY RODE SET UP

3.6.1 Chain Per Turn

This is the length of chain that is released during one complete turn of the chainwheel. The information for some windlasses is listed in Appendix 1. If your windlass is not listed follow the instructions below to calculate the chain per turn.

3.6.2 To Enter the Chain per Turn for Chain Only Rode

-  Select Chain per turn.
-  Enter the measurement. In mm or in metric inches (depending on units selected). See the table below for metric inch calculations.
-  Save and return to Rode Set up.
-  Exit to Windlass Set up.

Setting: _____

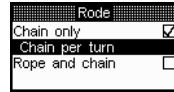

3.6.3 Calculating the Chain Per Turn

- Step 1* Use adhesive tape to place a mark on the chainwheel.
- Step 2* Use adhesive tape to place a mark on the chain coming out of the chain wheel.
- Step 3* Use adhesive tape to place a mark on the deck below the mark on the chain.
- Step 4* Carefully release the chainwheel so that it can be turned by hand to feed the chain out.
- Step 5* Using the mark on the chainwheel as a guide, turn the chainwheel one turn, causing the chain to be released on to the deck.
- Step 6* Measure the length of chain from the mark on the deck to the mark on the chain.
- Step 7* Enter this measurement (See below).

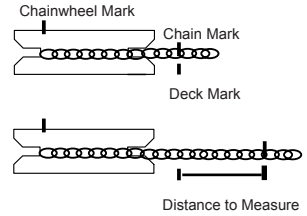

Metric Inches Conversion Table

Inches	Metric Inches	AutoAnchor Setting (to 1 decimal point)
1/8	0.125	0.1
1/4	0.25	0.3
3/8	0.375	0.4
1/2	0.5	0.5
5/8	0.625	0.6
3/4	0.75	0.8
7/8	0.875	0.9

3.7 ROPE AND CHAIN RODE SET UP

Some rope and chain windlasses have the settings already entered in the AutoAnchor. Refer to the Preset Windlass Profile List in Appendix 1. If your windlass is on the list select "Use preset" to enter the Windlass profile.

If your windlass is not on the list:

You will need to enter information for the chain and rope per turn. (See instructions on page 17).

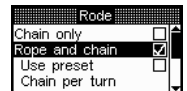

3.7.1 Selecting Use Preset

Setting: _____

Refer to the Preset Windlass Profile List list in Appendix 1.

- Ⓜ Select Use Preset.
- Ⓜ Select Windlass profile.
- ⚠ Scroll to the correct Windlass profile for your windlass.
- Ⓜ Save and return to Windlass Set up. There are no further settings.
- ⓪ Exit to Set up menu or hold for 2 seconds to return to the start screen.

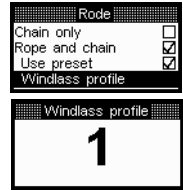

3.7.2 Chain per Turn for Rope and Chain Rode

This is the length of chain that is released during one complete turn of the chainwheel. The chain per turn for some windlasses is listed in Appendix 1. If your windlass is not listed, follow the instructions on page 16 to calculate it.

3.7.3 To Enter the Chain per Turn

- Ⓜ Select Chain per turn.
- ⚠ Enter the measurement in mm or metric feet (depending on the units selected). See the table for metric inch calculations.
- Ⓜ Save and return to Rode Set up.

Setting: _____

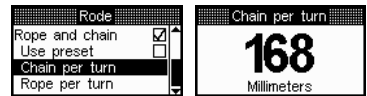

3.7.4 Rope per Turn for Rope and Chain Rode

This is the length of rope that is released during one complete turn of the chainwheel. You need to measure the length of rope pulled through for 10 turns and divide the result by 10. **See instructions below to calculate the rope per turn.**



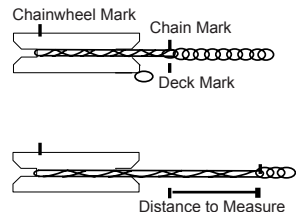

3.7.5 Calculating the Rope Per Turn

- Step 1** Carefully release the chainwheel so that it can be turned by hand to feed the rode out until you have rope.
- Step 2** As you did for the chain, use adhesive tape to mark the chainwheel, the deck and the rope. (See the instructions for the chain per turn above).
- Step 3** Using the mark on the chainwheel as a guide, pull the rope out by hand until the chainwheel has completed 10 turns.
- Step 4** Measure the length of rope pulled, divide it by 10.
- Step 5** Enter this measurement (See page 18).



3.7.6 To Enter the Rope per Turn

Setting:

-  Select Rope per turn.
-  Enter the measurement in mm or metric inches (depending on the units selected).
-  Save and return to Rode Set up. There are no further settings.
-  Exit to Windlass Set up. Press twice to exit to the Set Up menu or hold for 2 seconds to return to the start screen.

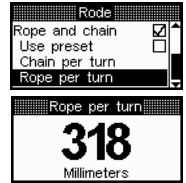

3.8 SENSOR SET UP





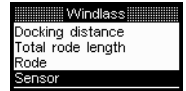



Default setting: **Standard - Applies to all AA sensors, reed switch baseplate sensors and proximity sensors.** The default setting should only be changed if you are using a motor driven sensor. (See below).

Note: The sensor is tuned to the system on first use. See page 21.





3.8.1 Motor Driven Sensors

To select the motor driven sensor:



-  Scroll to Sensor.
-  Select Sensor.
-  Scroll to Motor driven reed.
-  Select.
-  Scroll to Gearbox ratio.
-  Select Gearbox ratio.
-  Increase or decrease the Gearbox ratio.
-  Save and exit to the Sensor set up menu.
-  Exit to the Windlass set up menu or hold for 2 seconds to return to start screen.









3.9 SWAP CONTROLS

Default setting:  = Up and  = Down

Some operators prefer to use the buttons so that

 = Out and  = In

Access the swap controls feature via the Windlass Set up Menu.

-  Turn the AutoAnchor Off.
-  Hold together to access the Set up menu.
-  Scroll to Windlass.
-  Select Windlass.
-  Scroll to Swap Controls.
-  Select Swap Controls.
-  Exit to the Windlass Set Up or hold for 2 seconds to return to start screen.

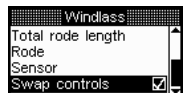
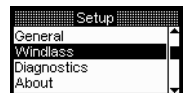

Note: This feature can not be used to correct wiring errors.

3.10 DRUM WINCH SET UP

Access via the Windlass Set Up Menu. 3 settings are required:

Total Rode Length.

Inside Diameter.

Outside Diameter with rode retrieved.

3.10.1 To Access Windlass Set up

- ⓪ Turn the AutoAnchor Off.
- Ⓜ + ⓪ Hold together to access the Set up menu.
- Ⓜ Ⓜ Scroll to Windlass.
- Ⓜ Select Windlass.

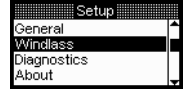

3.10.2 Set Total Rode Length

Add total length of chain plus total length of rope
 Default = 60m or 196ft. Minimum setting = 10m (33ft)

Setting: _____

- Ⓜ Ⓜ Scroll to Total rode length.
- Ⓜ Select Total rode length.
- Ⓜ Ⓜ Increase or decrease the value in meters or feet.
- Ⓜ Save and return to Windlass Set up.

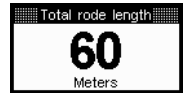
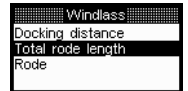

3.10.3 To Enter the Inside and Outside Diameter

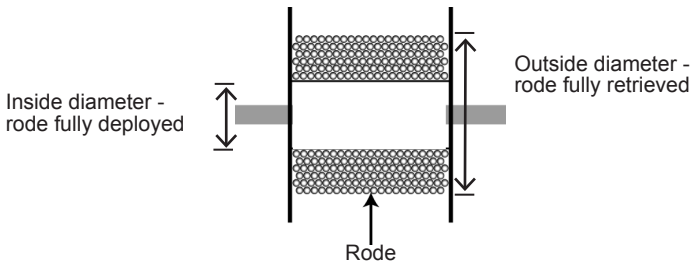

- Ⓜ Ⓜ Scroll to Rode.
- Ⓜ Select Rode.
- Ⓜ Ⓜ Scroll to Drum winch.
- Ⓜ Select Drum winch.
- Ⓜ Select Inside diameter.
- Ⓜ Enter the measurement in mm or metric inches (depending on the units selected).
- Ⓜ Save and return to Drum winch set up. Repeat for Outside Diameter.
- ⓪ Exit to Windlass Set up. Press twice to exit to the Set Up menu or hold for 2 seconds to return to the start up screen.

Inside Diameter: _____

Outside Diameter: _____

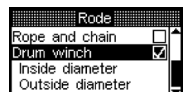
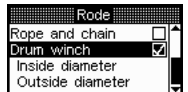

PART 4 OPERATION

AA560 BUTTONS

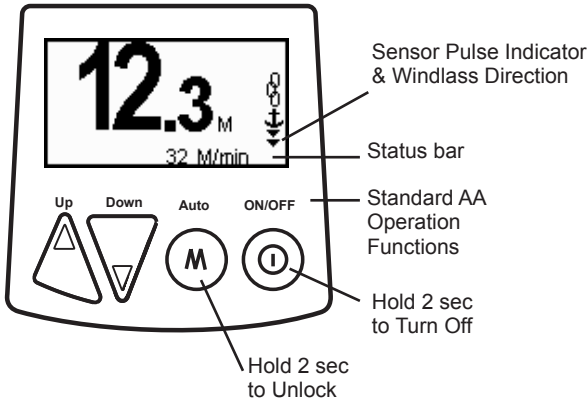

In an emergency shut off the power to the windlass using the isolating/breaker switch.

Note: Some operators prefer to swap the Up/Down buttons as follows: Up = Out and Down = In. See the instructions on page 18.

4.1 INFORMATION DISPLAYED DURING OPERATION

- The length of rode deployed in feet, metres or fathoms.
- The direction the anchor is moving.
- The type of rode being deployed (chain or rope).
- Windlass speed.

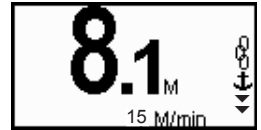

Settings and measurements are saved if the unit is turned off or the battery fails. Counting continues if the windlass is operated by another control eg foot switches.

4.1.1 Lock

The AutoAnchor is fitted with a lock to help protect against unintentional windlass operation.

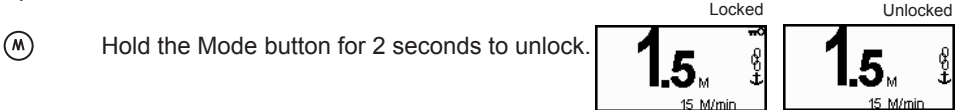

The lock automatically resets 5 minutes after the AutoAnchor was last operated or when the AutoAnchor is turned off. You can also reset the lock by holding down the  button until **the key** is displayed in the top right corner.

4.2 USER PRECAUTIONS

It is the owner's sole responsibility to ensure the AutoAnchor is installed, used and maintained in a manner that will not cause accidents, personal injury or property damage. When using the AutoAnchor the operator must use safe boating practices and safe windlass/winch and anchoring operation

- use the windlass/winch strictly according to the manufacturer's instructions;
- only persons who are fully aware of the correct use of the windlass/winch should be allowed to use the AutoAnchor to control this equipment;
- the user must personally control and supervise all anchoring operations;
- the user must know the location of the main breaker or battery switch to disconnect the windlass/winch from all power sources in the event of an emergency;
- the windlass/winch power supply must be turned off when the equipment is not in use;
- there must be an alternative method available to operate the windlass/winch.

When Controlling a Windlass/Winch

- maintain a clear view of the windlass/winch, rode and/or anchor during operation;
- always ensure the anchor is fully **docked and secured** before moving the boat.

4.3 SET UP AND TESTING

Before use the AutoAnchor must be correctly set up for the equipment it is to control and then tested in a safe environment. The AutoAnchor will not count correctly if the windlass selection is wrong or the windlass is not standard (eg it is installed with a different chainwheel or motor).

4.3.1 PLUG & PLAY SENSOR TUNING

Required for all sensors other than a motor driven reed sensor. This screen automatically displays on first use or if Factory Defaults are loaded, the sensor is reset or there has been a loss of sensor signal.

Installation and set up must be complete and the anchor must be docked before starting this process.

Clear the AutoAnchor to zero if necessary. (See page 24).

Deploy the anchor using the AutoAnchor. Initially the status bar will display "**Sensor tuning**". Continue deployment until this message changes to "**Tuning done**". **This must be done in one continuous operation without taking your finger off the button until the "Tuning done" message displays. This could take up to 10 turns of the windlass.** Retrieve the anchor to the docked position and clear to zero if needed.

Note: If you do need to take your finger off the button, start the process again.

Rope/Chain Systems: The default rode set up is chain only. If rope and chain rode is selected without the correct sensor and magnet set up a "Sensor installation not compatible with rope and chain setting" message will display. Check the installation and rode set up and reset the sensor to restart the tuning process.

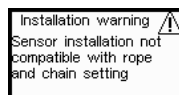



4.4 AUTOMATIC AND MANUAL OPERATION

Keep your finger on the button to deploy the anchor manually or use the automatic function for hands free anchor deployment and retrieval. See the instructions for both options below.

For an accurate reading always ensure the AutoAnchor display reads 0.0 before deploying the anchor.

4..4.1 MANUAL OPERATION

Deploy and Retrieve the Anchor Using Manual Operation.

-  Turn the AutoAnchor on.
-  Clear the safety lock.
-  Hold down the up or down button to deploy or retrieve the anchor. Releasing the button stops the windlass operation.

Ensure the anchor is fully docked and secured before moving the boat.

DOCKING ALARM: During retrieval the windlass will stop and the AutoAnchor beeps to warn the operator the anchor is at the preset docking distance. Press and hold the button to continue retrieval.

Extra care must be taken at this stage of retrieval.



4.4.2 AUTOMATIC OPERATION



WARNING: There is an inherent risk when using any automatic function on a boat. If you choose to use the AutoAnchor automatic functions, you must still control and supervise all windlass and anchoring operation.

Use the Automatic Function to:

- Preset the length of rode for deployment.
- Have hands-free operation of the windlass.
- Retrieve the anchor automatically to the preset docking distance.

Note: For rope/chain counting, if the sensor or load sensing wires are not installed correctly the automatic function **will not operate**. An Installation warning message will display on the screen. The windlass can still be operated using manual operation but on retrieval the display may be incorrect because it cannot allow for the stretch in the rope.

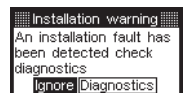

Safety Override



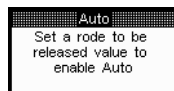

Press any button on the AutoAnchor to stop the windlass during automatic release or retrieval. **In an emergency shut off the power to the windlass using the isolating/breaker switch.**

Enable Automatic Operation

A “rode to be released” value must be entered to use automatic operation.



To Set A Rode to be Released Value





-  Turn the AutoAnchor on.
-  Clear the safety lock.
-  Press the Mode button twice to enter Set auto.
-  Scroll up or down to change the value.
-  Save ready to deploy. Press twice to return to start screen.

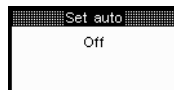

To disable the automatic operation: Set the rode to be released value to Off.



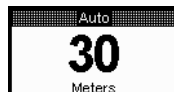

Deploy the Anchor Using Automatic Operation

-  Turn the AutoAnchor on.
-  Clear the safety lock.
-  Press the Mode button to select Auto. The screen displays the current length for Auto release.
-  If this setting is correct. Press and release the down button to deploy the anchor.



To Change the setting:





-  Press the Mode button again to select Set auto.
-  Enter the value.
-  Save and return to Auto.



The windlass will stop and the AutoAnchor will beep when the preset length of rode has been released. The screen will display “Auto target reached”.



Retrieve the Anchor Using Automatic Operation

-  Turn the AutoAnchor on.
-  Clear the safety lock.
-  Press the Mode button to Select Auto.
-  Press and release the Up button to retrieve the anchor. The windlass will stop and the AutoAnchor will beep when the docking distance is reached. The screen will display Docking distance.
-  Press the Up button to complete retrieval of the anchor. The AutoAnchor will beep during this process.

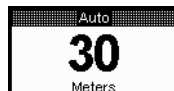







Ensure the anchor is fully docked and secured before moving the boat.

4.3 OTHER OPERATION SETTINGS

Press  to access the menu when the AutoAnchor is turned on.

4.3.1 To Clear to Zero



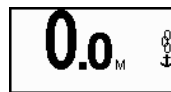
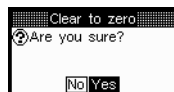

The AutoAnchor must be turned on.

-  Press to access the Menu.
-  Select clear to zero.
-  Select No/Yes.
-  **Yes** - return to start screen.
-  **No** - return to the menu, then press  again to return to the start screen.



4.3.2 To Check Logs

The AutoAnchor must be turned on.

-  Press to access the Menu.
-  Select Logs.
-  Return to the menu.
-  Exit and return to start screen.

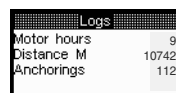





Logs are cleared using the Factory Default Settings. See page 14.



Resetting the Factory Defaults clears all logs and calibrations.

4.3.4 To Adjust Backlight





The AutoAnchor must be turned on. It is best to change this setting in low light.

-  Press to access the Menu.
-  Select Backlight.
-  Change the Backlighting level.
-  Save and return to the menu.
-  Exit and return to start screen.



4.3.5 To Reset Sensor

The AutoAnchor must be turned on.

-  Press to access the Menu.
-  Select Reset sensor.
-  Select No/Yes.
-  Save and return to the menu.
-  Exit and return to start screen.
- Deploy the anchor to tune the sensor.
See page 21.

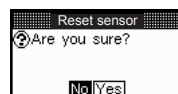
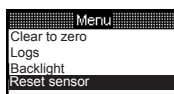

PART 5 MAINTENANCE

The AutoAnchor does not contain any user servicable parts.

User maintenance is limited to:

- Checking all cables and connections for signs of wear or damage and replacing them as necessary.
- Checking the sensor head is not worn and has not moved out of alignment with the magnet and replacing the sensor if necessary. **After any sensor repairs or changes to sensor installation reset the sensor. See Page 24.**
- Checking the magnet is not worn or corroded and replacing the magnet if necessary.

Note: Do not use chemical or abrasive materials to clean the console unit. If it is dirty wipe it with a clean damp cloth. Avoid wiping the display screen with a dry cloth as this could scratch the screen.

PART 6 TROUBLESHOOTING

Messages are displayed on the AA560 console screen to assist with operation and troubleshooting. These messages are designed to assist the user. They may be **information messages**, for example that the console is locked, or the sensor is tuning. They may also be **diagnostic messages**, for example, that the sensor installation is not compatible or the power supply is wired incorrectly.

Many of the messages are self explanatory. Some will require further diagnostics. See the Troubleshooting Messages, the Diagnostics Table and the Internal Voltmeter/Test Tool information on the following pages.

Please Note: The messages are designed to help find an installation problem. They are triggered by external wiring, installation or set up issues which need fixing. **They are not caused by a fault with the AutoAnchor.**

TROUBLESHOOTING MESSAGES	POSSIBLE CAUSE/ACTION
1. Auto mode disabled <i>Note: Unless the fault is in the solenoid wiring the AA560 will operate the windlass in manual mode when this message is displayed.</i>	Auto mode is disabled when: 1. No sensor pulses are detected. See message 6 below. 2. The sensor installation is not compatible with rope and chain settings. See message 7 below. 3. The load sensing wires are not connected for rope/chain counting. See the rope/chain wiring diagram and message 7 below. 4. A solenoid wire is disconnected. See message 9 below. 5. No rode to be released value has been entered. See page 23. 6. Total rode is set to OFF. See page 15.
2. Battery voltage too low to operate windlass. <i>The voltage displays on the status bar.</i>	1. If the battery is fully charged, check the wiring for bad connections. 2. Check the cable meets the specifications. If the cable is the wrong size there may be voltage drop between the battery and the AutoAnchor. See cable sizes on page 11. Go to the Diagnostics in the Set up menu to view the battery information. See the table on page 29.

TROUBLESHOOTING MESSAGES Cont'd	POSSIBLE CAUSE/ACTION
3. Installation warning	Appears when switching on the AutoAnchor. Go to Diagnostics for more information.
4. Motor externally controlled.	<ol style="list-style-type: none"> 1. Another control is being used for the windlass. 2. Solenoid common ground is not connected or swapped with an up or down terminal. 3. Large voltage potential difference between AA560 Ground and Solenoid common ground.
5. Power supply wired incorrectly. <i>The AA560 will beep.</i>	The wiring diagram has not been followed. Power is backfeeding to the AutoAnchor from a supply outside the control circuit. Refer to wiring diagram. Common example of incorrect wiring is AA560 and deck switches powered from separate sources.
6. Sensor: No sensor pulses detected. <i>Note: The AA560 will continue to operate the windlass up and down in manual mode when this message is displayed. It will not count.</i>	<ol style="list-style-type: none"> 1. Use manual operation to check the windlass speed is more than the minimum operating speed of 5 metres per minute. Windlass speed is displayed on the status bar. 2. Check the correct windlass set up and sensor has been selected. See pages 15-18. 3. Check the magnet and sensor installation. 4. Check the magnet and sensor are not damaged (eg rusted magnet). 5. Check the gap between the magnet and sensor is correct for your set up. 6. If using a rope/chain system check that the sensor installation is compatible with a rope/chain set up. See message 7 below. 7. Go to Diagnostics in the Set Up Menu to view sensor voltages. See the tables on pages 28 -29.
7. Sensor: Sensor installation not compatible with rope and chain settings. <i>Note: The AA560 will continue to operate the windlass up and down in manual mode when this message is displayed. Counting will not be accurate.</i>	<p style="text-align: center;">APPLIES TO ROPE/CHAIN SYSTEMS ONLY</p> <ol style="list-style-type: none"> 1. Check the correct windlass set up has been selected. See page 15. 2. Check magnet and sensor installation is correct. The grey AA sensor must be installed for rope/chain counting. The magnet must be installed in the top of the chainwheel and the sensor must be fitted as per figure 5 on page 7. 3. Check that the load sensing wires are connected. Refer to the rope/chain wiring diagram. 4. Go to Diagnostics in the Set Up Menu to view sensor signal readouts. See tables on page 28 -29.
8. Sensor: Sensor tuning and tuning done	<ol style="list-style-type: none"> 1. The plug and play sensor detector is operating. Deploy the rode through the windlass until the message changes to "Tuning done" then dock the anchor. See page 21. 2. If the "sensor tuning" message does not change to "tuning done" after 10 turns of the windlass, check the sensor installation is correct.
9. Solenoid is disconnected, shorted or stuck on.	<ol style="list-style-type: none"> 1. Use another control to check the solenoid is operating the windlass. 2. Go to Diagnostics in the Set up menu to view the solenoid wiring readouts. See the table on page 29. 3. Check solenoid wiring for open circuit or short circuit.

OTHER TROUBLESHOOTING	POSSIBLE CAUSE/ACTION
1. AutoAnchor beeps when it is turned off or locked.	1. The unit beeps when it receives a sensor pulse. This could be because the windlass is being controlled by a means other than the AutoAnchor. This is not an error. 2. If the windlass is not operating then review the actions set out in section 2 below.
2. AutoAnchor counts when the windlass is not turning or counts erratically displaying a large number. The screen may display Sensor unstable and the unit may beep when turned off or locked.	1. Uncontrolled anchor rode could be running through the windlass or there may be some external interference. 2. The sensor may be damaged. The sensor cable is not the specified type or the connection may be faulty. 3. Check the sensor wiring. If the AA sensor plug is not used the wires must be soldered. All wires must be connected (including the drain) and shielded cable must be used.
3. AutoAnchor counts but does not operate the windlass. Displays message - <i>Motor disabled because total rode length is set to OFF.</i>	Total length of rode has been set to off. AutoAnchor then operates as a counter only. See page 15.
4. The count pauses during retrieval. <i>This applies to rope/chain rode only.</i>	If the sensor indicator (arrow) is still pulsing, this is not a fault. The rode is changing from rope to chain.
5. The count stays on zero when rode is deployed and counts out when rode is retrieved.	The unit is not receiving correct direction information. Solenoid up and down wires are swapped.
6. Windlass deploys when the Up button is pressed and retrieves when the Down button is pressed.	1. The motor or solenoid wiring is reversed. Change the wiring and check the direction of windlass rotation. If the brown and white wires are connected, also check that they are correct after you have changed the wiring. 2. Buttons are swapped in the windlass menu. See page 18.
7. Windlass does not stop exactly at the preset point.	Stopping is accurate to +1 chainwheel revolution. The chainwheel will run on slightly with momentum.
8. Windlass stops before the length of rode specified is deployed.	Using the Automatic function the rode release stops 10ft (3m) short of the Total Length of Rode on Board setting.

**AFTER ANY SENSOR REPAIRS OR CHANGES:
DOCK THE ANCHOR AND RESET THE SENSOR. SEE PAGE 24.**

FOR ADDITIONAL TROUBLESHOOTING:

Contact AutoAnchor support on:

www.autoanchor.co.nz/autoanchor-installation-help.php Fill in the information form.

Email: support@autoanchor.co.nz or Telephone: +64 9 360 0300

PART 7 TECHNICIAN DIAGNOSTIC INFORMATION

Diagnostic messages help find an installation problem. The diagnostic messages are all caused by external wiring, set up or installation issues which need fixing. They are not caused by a fault with the AutoAnchor.

INTERNAL VOLTMETER/TEST TOOL: This tool displays the voltages and status of sensor, battery and load wires. The information is required by the AutoAnchor support team for effective technical assistance.

Contact AutoAnchor support on:

www.autoanchor.co.nz/autoanchor-installation-help.php Fill in the information form.

or

Email: support@autoanchor.co.nz or Telephone: +64 9 360 0300.

Access the information from the Set up menu or from the installation warning screen.

The AutoAnchor must be turned off to access the Set up menu.

Hold (M)+(O) together to display the Set up menu.

Use (A)(V) to scroll through the menus and (M) to select Diagnostics.

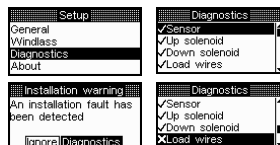

Press (M) again for extended diagnostic information and test tools.

To update the recorded signal levels rotate the windlass 2 or more turns

Press (A)(V) buttons or freewheel the windlass to rotate.

Check the windlass is safe and clear before using this function.

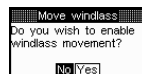

Sensor Information

Sensor	Source icon Signal Voltage (V) Signal (mV)	<input checked="" type="checkbox"/> Correct Parameters
AA Grey Sensor Chain Only Set Up Bottom Fit Magnet Polarity not relevant		Signal A - (Red sensor wire from the console) is sensor power supply. Voltage must be between 4.6V and 5.0V. Signal B - Reading depends on gap and magnet polarity. Range 0.5V - 4.6V. Minimum working signal 0.5V. Signal C - If Signal B is less than 0.5V then Signal C will take over and operate down to 100mV for an all chain set up.
AA Grey Sensor Rope/Chain Set Up Top Fit Magnet Polarity not relevant		Signal A - (Red sensor wire from the console) is sensor power supply. Signal B - Reading is not relevant. Signal C - Minimum value is 100 mV when reading the chain pulses.
AA Black Sensor Chain Only Set Up Bottom Fit Magnet South pole must face sensor		Signal A - (Red sensor wire from the console) moves between 2.6V and 4.6V. Minimum working signal 0.5V. Signal B - Reading is not relevant Signal C - Reading is not relevant.
Reed Switch Chain Only Set Up Bottom Fit Magnet Polarity not relevant		Signal A - (Red sensor wire from the console) is not used. Black sensor wire (from the console) is connected to the reed switch. Signal B - Range is 0.0V to 5V. Signal C - Reading is not relevant.
NPN Proximity Sensor Chain Only Set Up		Signal A - (Red sensor wire from the console) is the proximity sensor's power supply. Signal B - Range 2.5V - 4.6V. Minimum working signal 0.5V Signal C - Reading is not relevant.

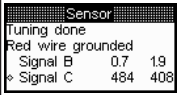
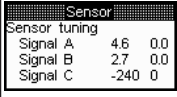
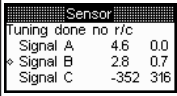
Sensor Installation Diagnostic Messages		
<p>These messages appear when the AA560 is turned on. Go to the extended diagnostics for more information. After fixing the sensor installation retune the sensor. See page 21.</p>		
Red sensor wire grounded	 <pre> Sensor ----- tuning done Red wire grounded Signal B 0.7 1.9 Signal C 484 408 </pre>	<p>The Red sensor wire is overloaded below 2.5 volts Disconnect the plugs one at a time to locate the short or excessive load. If no short is found, the sensor may be damaged. Try a new sensor. <i>Windlass will operate but not count.</i></p>
No Sensor pulses	 <pre> Sensor ----- Sensor tuning Signal A 4.6 0.0 Signal B 2.7 0.0 Signal C -240 0 </pre>	<p>Electrical connections are OK (voltages are correct) but no sensor pulses are being received by the console and it is not counting. Rotate the windlass to check for signal voltage. If there is still no signal either the magnet or the sensor needs replacing. Check the magnet is strong and not rusted and check the sensor for physical damage.</p>
Sensor installation not compatible with rope and chain settings.	 <pre> Sensor ----- tuning done no r/c Signal A 4.6 0.0 Signal B 2.8 0.7 Signal C -352 316 </pre>	<p>A rope/chain rode has been selected but the installation is not compatible with this selection. The system is tuned to the Signal B sensor input (all chain) instead of Signal C sensor input (rope/chain). Possible causes: Magnet is installed on the bottom of chainwheel instead of the top The sensor is not the grey AA sensor. The windlass has been operated with no chain so the tuning is incorrect.</p>

Other Diagnostic Messages	Possible Causes and Solutions
Up Solenoid	<p>Check the solenoid wires are properly connected. Solenoid common ground is not connected or swapped with an up or down terminal. The load connected to the solenoid wires is insufficient. Check that each solenoid wire has a load of more than 10mA (12V DC) or 20mA (24V DC). The idle voltage is greater than 2.0V - this can occur when connecting to a solid state or low current drive windlass control eg PLC or AC VFD. A dummy resistor load Part #9515 may be required to fix this.</p>
Down Solenoid	
Load wires	<p>These wires are used for combination rope and chain rodes. They are not required for chain only use. When correctly connected to the motor terminal both wires show nearly zero volts at idle. Under load they show motor ground and supply terminal voltages.</p>
Battery	<p>The voltage at the time of failure is recorded on the status bar.</p> <p>This page records the voltage drop when the motor is started. In this example the supply voltage to the AA560 fell below 6V for a short period. The power supply wiring has high resistance or is too thin for the distance of the run or the ground wire is disconnected.</p>

Appendix 1

1.1 Chain per Revolution for Chain Only Windlasses

Enter the chain per revolution for the windlass.

If your windlass is not listed below, refer to the Operation Manual for instructions to calculate the chain per revolution.

LEWMAR CHAIN ONLY WINDLASSES

Chainwheel	Chain Size	Chain per Revolution
603	1/4" 7 mm	205mm (8.07 inches)
604	5/16" 8 mm	290mm (11.42 inches)
001	5/16" 8mm	330mm (12.99 inches)
002	5/16" 8mm	310mm (12.20 inches)
002	3/8" 9.5mm	10 mm 330mm (12.99 inches)
003	3/8" 9.5mm	10 mm 295mm (11.61 inches)

LOFRANS CHAIN ONLY WINDLASSES

Windlass Model	Chainwheel Reference	Chain Size	Chain per Revolution
Project 1000-1000W	916b	5/16"	272 mm (10.7 inches)
Project 1500-1200W	989a 80102	5/16"	307 mm (12.1 inches)
Project 1500-1200W	989b 10103	3/8"	295 mm (11.6 inches)
Project 1500-1500W	989a 80102	5/16"	307 mm (12.1 inches)
Project 1500-1500W	989b10103	3/8"	295 mm (11.6 inches)

MAXWELL CHAIN ONLY WINDLASSES

Windlass Model	Chainwheel Reference	Chain Size	Chain per Revolution
Freedom 500	P100030	1/4"(7mm)	295 mm (11.6 inches)
Freedom 500M	P100031	6 mm	292 mm (11.5 inches)
Freedom 800	P100033	5/16"	256 mm (10.1 inches)
Freedom 800M	P100034	8 mm	290 mm (11.4 inches)
HRC 6 or HRC 8	6050/1	6 mm	295 mm (11.6 inches)
HRC 6 or HRC 8	6062/3	1/4"(7 mm)	300 mm (11.8 inches)
HRC 8	6074/5	8 mm	290 mm (11.4 inches)
HRC 8	6086/7	5/16"	310 mm (12.2 inches)
Liberty	5220/P101525	3/8" (10 mm)	330 mm (13.0 inches)
Liberty	5346/P101542	5/16"	360 mm (14.2 inches)
Liberty	5443/P101547	8 mm	340 mm (13.4 inches)
RC10	P103309	3/8" (10mm)	322 mm (13.01 inches)

MUIR CHAIN ONLY WINDLASSES

Windlass Model	Chainwheel Reference	Chain Size	Chain per Revolution
Atlantic 600	116	1/4"(6 mm)	248 mm (9.76 inches)
Atlantic 600	117	1/4"	210 mm (8.27 inches)
Atlantic 850-1250	66	1/4" (6 mm)	316 mm (12.44 inches)
Atlantic 850-1250 & 2200	80	5/16"(8 mm)	328 mm (12.91 inches)
Atlantic 850-1250 & 2200	99	3/8"(10 mm)	322 mm (12.68 inches)
Atlantic 850-1250 & 2200	112	3/8" (10 mm)	310 mm (12.2 inches)
Atlantic 850-1250	120	5/16"(8 mm)	330 mm (12.99 inches)
Atlantic 2200, 2500, 3500, 4000	121	5/16"(8 mm)	377 mm (14.84 inches)
Atlantic 2200, 2500, 3500, 4000	130	13 mm	400 mm (15.75 inches)
Atlantic 2500, 3500, 4000	57	5/16"	405 mm (15.94 inches)
Atlantic 2500, 3500, 4000	60	3/8" HT	368 mm (14.49 inches)
Atlantic 2500, 3500, 4000	61	3/8" BBB	380 mm (14.96 inches)
Atlantic 2500, 3500, 4000	114	1/2" DIN 766	420 mm (16.54 inches)
Atlantic 2500, 3500, 4000	119	3/8"(10 mm)	405 mm (15.94 inches)
Atlantic 2500, 3500, 4000	130	13 mm	400 mm (15.75 inches)
Atlantic 2500, 3500, 4000	131	7/16" (12.5 mm)	420mm (16.54 inches)

1.2 Pre-set Windlass Profile List for Rope & Chain Windlasses

Find the windlass model.

Check the chainwheel reference.

Check the chain size.

Check the rope size.

Select the AutoAnchor reference number.

If your windlass is not on the list, you need to calculate the length of chain and rope that is released during one complete revolution of the chainwheel. See Operation Manual for instructions.

LEWMAR ROPE & CHAIN WINDLASSES

Windlass	Motor	Volts	Chainwheel Reference	Chain Size	Rope Size 3 Strand	AutoAnchor Reference
Lewmar Sprint 600	250W		12 603	1/4" 7mm	1/2" 12mm	128
Lewmar Sprint 1000	400W		12 604	5/16" 8mm	9/16" 14mm	129
Lewmar V2	700W		12 001	5/16" 8 mm	9/16" 14mm	123
Lewmar V2	700W		12 001	5/16" 8mm	5/8" 16mm	122
Lewmar V2	700W		12 002	3/8" 9.5mm	9/16" 14mm	119
Lewmar V2	700W		12 002	3/8" 9.5mm	5/8" 16mm	118
Lewmar V2	700W		12 002	5/16" 8mm	9/16" 14mm	114
Lewmar V2	700W		12 002	5/16" 8mm	5/8" 16mm	113
Lewmar V2	1000W		12 003	3/8" 9.5mm	5/8" 16mm	120
Lewmar V3	1000W		12 002	5/16" 8mm	5/8" 16mm	116
Lewmar V3	1000W		12 001	5/16" 8 mm	5/8" 16 mm	126
Lewmar V3	1000W		12 001	5/16" 8 mm	9/16" 14mm	127
Lewmar V3	1000W		12 002	3/8" 9.5mm	9/16" 14mm	124
Lewmar V3	1000W		12 002	5/16" 8 mm	9/16" 14mm	117
Lewmar V700	320W		12 765 + 670	1/4" 7mm	1/2" 12mm	130
Lewmar V700	320W		12 670	1/4" 6mm	1/2" 12mm	130
Lewmar Pro-Series 700	500W		12 762	1/4" 7mm	5/8" 16mm	131

LOFRANS ROPE & CHAIN WINDLASSES

Windlass Model	Chainwheel	Chain Size	Rope Size	AutoAnchor Reference
Dorado		7mm	14mm	65
Dorado		7mm	12 mm	66
Project 1000-1000W	916b	5/16"	5/8" (16mm) 3 strand	61
Project 1000-1000W	916b	5/16"	5/8" (16 mm) 8 plait	62
Project 1000-1000W	916b	5/16"	9/16" (14 mm) 3 strand	63
Project 1000-1000W	916b	5/16"	9/16" (14 mm) 8 plait	64
Project 1500-1200W	989a 80102	5/16"	5/8" (16 mm) 3 strand	55
Project 1500-1200W	989a 80102	5/16"	5/8" (16 mm) 8 plait	56
Project 1500-1200W	989b 10103	3/8" (10 mm)	3/4" (20 mm) 3 strand	57
Project 1500-1200W	989b 10103	3/8" (10 mm)	3/4" (20 mm) 8 plait	58
Project 1500-1200W	989b 10103	3/8" (10 mm)	5/8" (16 mm) 3 strand	59
Project 1500-1200W	989b 10103	3/8" (10 mm)	5/8" (16 mm) 8 plait	60
Project 1500-1500W	989a 80102	5/16"	5/8" (16 mm) 3 strand	49
Project 1500-1500W	989a 80102	5/16"	5/8" (16 mm) 8 plait	50
Project 1500-1500W	989b10103	3/8" (10 mm)	5/8" (16 mm) 3 strand	47
Project 1500-1500W	989b10103	3/8" (10 mm)	5/8" (16 mm) 8 plait	48
Project 1500-1500W	989b10103	3/8" (10 mm)	3/4" (20 mm) 3 strand	46
Project 1500-1500W	989b10103	3/8" (10 mm)	3/4" (20 mm) 8 plait	45

MAXWELL ROPE & CHAIN WINDLASSES





Windlass Model	Chainwheel Reference	Chain Size	Rope Size	AutoAnchor Reference
Freedom 500	P100030	¼" (7 mm)	½" (12 mm) 3 strand	35
Freedom 500	P100030	¼" (7 mm)	½" (12 mm) 8 plait	34
Freedom 500-1000W	P100030	¼" (7 mm)	½" (12 mm) 3 strand	21
Freedom 500M	P100031	6 mm	½" (12 mm) 3 strand	2
Freedom 500M	P100031	6 mm	½" (12 mm) 8 plait	33
Freedom 500M-1000W	P100031	6 mm	½" (12 mm) 3 strand	22
Freedom 800	P100033	5/16"	5/8" (16 mm) 3 strand	40
Freedom 800	P100033	5/16"	5/8" (16 mm) 8 plait	39
Freedom 800	P100033	5/16"	½" (12 mm) 3 strand	36
Freedom 800	P100033	5/16"	½" (12 mm) 8 plait	37
Freedom 800	P100033	5/16"	9/16" (14 mm) 3 strand	38
Freedom 800M	P100034	8 mm	9/16" (14 mm) 3 strand	1
Freedom 800M	P100034	8 mm	½" (12 mm) 3 strand	41
Freedom 800M	P100034	8 mm	½" (12 mm) 8 plait	42
HRC 6	6050/1	6 mm	½" (12 mm) 3 strand or 8 plait	23
HRC 6	6062/3	¼" (7mm)	½" (12 mm) 8 strand or 8 plait	24
HRC 8	6050/1	6 mm	½" (12 mm) 3 strand or 8 plait	25
HRC 8	6062/3	¼" (7 mm)	½" (12 mm) 3 strand or 8 plait	26
HRC 8	6074/5	8 mm	9/16" (14 mm) 3 strand or 8 plait	27
HRC 8	6074/5	8 mm	5/8" (16 mm) 3 strand or 8 plait	28
HRC 8	6086/7	5/16"	½" (12 mm) 3 strand	29
HRC 8	6086/7	5/16"	½" (12 mm) 8 plait	30
HRC 8	6086/7	5/16"	9/16" (14 mm) 3 strand	31
HRC 8	6086/7	5/16"	5/8" (16 mm) 3 strand	32
Liberty - 1000 Watt	5220/P101525	3/8" (10 mm)	¾" (20 mm) 3 strand	7
Liberty - 1000 Watt	5220/P101525	3/8" (10 mm)	¾" (20 mm) 8 plait	8
Liberty - 1000 Watt	5346/P101542	5/16"	5/8" (16 mm) 3 strand	5
Liberty - 1000 Watt	5346/P101542	5/16"	5/8" (16 mm) 8 plait	6
Liberty - 1000 Watt	5443/P101547	8 mm	5/8" (16 mm) 3 strand	3
Liberty - 1000 Watt	5443/P101547	8 mm	5/8" (16 mm) 8 plait	4
Liberty - 1200 Watt	5220/P101525	3/8" (10 mm)	¾" (20 mm) 3 strand	13
Liberty - 1200 Watt	5220/P101525	3/8" (10 mm)	¾" (20 mm) 8 plait	14
Liberty - 1200 Watt	5346/P101542	5/16"	5/8" (16 mm) 3 strand	11
Liberty - 1200 Watt	5346/P101542	5/16"	5/8" (16 mm) 8 plait	12
Liberty - 1200 Watt	5443/P101547	8 mm	5/8" (16 mm) 3 strand	9
Liberty - 1200 Watt	5443/P101547	8 mm	5/8" (16 mm) 8 plait	10
Liberty - 1500 Watt	5220/P101525	3/8" (10 mm)	¾" (20 mm) 3 strand	19
Liberty - 1500 Watt	5220/P101525	3/8" (10 mm)	¾" (20 mm) 8 plait	20
Liberty - 1500 Watt	5346/P101542	5/16"	5/8" (16 mm) 3 strand	17
Liberty - 1500 Watt	5346/P101542	5/16"	5/8" (16 mm) 8 plait	18
Liberty - 1500 Watt	5443/P101547	8 mm	5/8" (16 mm) 3 strand	15
Liberty - 1500 Watt	5443/P101547	8 mm	5/8" (16 mm) 8 plait	16
RC10	P103309	3/8" (10mm)	5/8" (16 mm) 3 strand	43

MUIR ROPE & CHAIN WINDLASSES

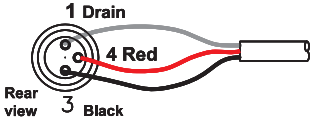

Windlass Model	Voltage	Chainwheel Reference	Chain Size	Rope Size	AutoAnchor Reference
Atlantic 600	12V	116	1/4" (6 mm)	1/2" (12 mm) 3 strand	68
Atlantic 600	12V	117	1/4" (6 mm)	1/2" (12 mm) 3 strand	69
Atlantic 850	12V	66	1/4" (6 mm)	1/2" (12 mm) 3 strand	70
Atlantic 850	12V	80	5/16" (8 mm)	1/2" (12 mm) 3 strand	85
Atlantic 850	12V	80	5/16" (8 mm)	9/16" (14 mm) 3 strand	72
Atlantic 850	12V	99	3/8" (10 mm)	5/8" (16 mm) 3 strand	73
Atlantic 850	12V	112	3/8" (10 mm)	5/8" (16 mm) 3 strand	71
Atlantic 850	12V	120	5/16" (8 mm)	9/16" (14 mm) 3 strand	86
Atlantic 850	12V	120	5/16" (8 mm)	9/16" (14 mm) 3 strand	74
Atlantic 1000/1250	12/24V	66	1/4" (6 mm)	1/2" (12 mm) 3 strand	75
Atlantic 1000/1250	12/24V	80	5/16" (8 mm)	9/16" (14 mm) 3 strand	77
Atlantic 1000/1250	12/24V	99	3/8" (10 mm)	5/8" (16 mm) 3 strand	78
Atlantic 1000/1250	12/24V	112	3/8" (10 mm)	5/8" (16 mm) 3 strand	76
Atlantic 1000/1250	12/24V	120	5/16" (8 mm)	9/16" (14 mm) 3 strand	79
Atlantic 1200	12/24V	66	1/4" (6 mm)	1/2" (12 mm) 3 strand	80
Atlantic 1200	12/24V	80	5/16" (8 mm)	9/16" (14 mm) 3 strand	82
Atlantic 1200	12/24V	99	3/8" (10 mm)	5/8" (16 mm) 3 strand	83
Atlantic 1200	12/24V	112	3/8" (10 mm)	5/8" (16 mm) 3 strand	81
Atlantic 1200	12/24V	120	5/16" (8 mm)	9/16" (14 mm) 3 strand	84
Atlantic 2200	12/24V	80	5/16" (8 mm)	9/16" (14 mm) 3 strand	88
Atlantic 2200	12/24V	99	3/8" (10 mm)	5/8" (16 mm) 3 strand	89
Atlantic 2200	12/24V	112	3/8" (10 mm)	5/8" (16 mm) 3 strand	87
Atlantic 2500	12/24V	57	5/16" (8mm)	5/8" (16 mm) 3 strand	90
Atlantic 2500	12/24V	60	3/8" (10 mm) HT	3/4" (19 mm) 3 strand	92
Atlantic 2500	12/24V	61	3/8" (10 mm) BBB	3/4" (19 mm) 3 strand	93
Atlantic 2500	12/24V	114	1/2" (12.5mm)	7/8" (22mm) 3 strand	94
Atlantic 2500	12/24V	119	3/8"(10 mm)	3/4" (19 mm) 3 strand	97
Atlantic 2500	12/24V	121	5/16" (8 mm)	5/8" (16 mm) 3 strand	91
Atlantic 2500	12/24V	130	13 mm	7/8" (22 mm) 3 strand	96
Atlantic 2500	12/24V	131	1/2" (12.5 mm)	7/8" (22 mm) 3 strand	94
Atlantic 3500	12/24V	60	3/8" (10 mm) HT	3/4" (19 mm) 3 strand	100
Atlantic 3500	12/24V	61	3/8" (10 mm) BBB	3/4" (19 mm) 3 strand	101
Atlantic 3500	12/24V	114	1/2" (12.5 mm)	7/8" (22 mm) 3 strand	102
Atlantic 3500	12/24V	119	3/8"(10 mm)	3/4" (19 mm) 3 strand	99
Atlantic 3500	12/24V	130	13 mm	7/8" (22 mm) 3 strand	103
Atlantic 3500	12/24V	131	1/2" (12.5mm)	7/8" (22 mm) 3 strand	102
Atlantic 4000(1500W)	12V	60	3/8" (10 mm) HT	3/4" (19 mm) 3 strand	105
Atlantic 4000(1500W)	12V	61	3/8" (10 mm) BBB	3/4" (19 mm) 3 strand	106
Atlantic 4000(1500W)	12V	119	3/8" (10 mm)	3/4" (19 mm) 3 strand	104
Atlantic 4000(1500W)	12V	130	13 mm	7/8" (22 mm) 3 strand	110
Atlantic 4000(2000W)	24V	60	3/8" (10 mm) HT	3/4" (19 mm) 3 strand	108
Atlantic 4000(2000W)	24V	61	3/8" (10 mm) BBB	3/4" (19 mm) 3 strand	109
Atlantic 4000(2000W)	24V	114	1/2" (12.5 mm)	7/8" (22 mm) 3 strand	112
Atlantic 4000(2000W)	24V	119	3/8" (10 mm)	3/4" (19 mm) 3 strand	107
Atlantic 4000(2000W)	24V	130	13 mm	7/8" (22 mm) 3 strand	111
Atlantic 4000(2000W)	24V	131	1/2" (12.5 mm)	7/8" (22 mm) 3 strand	112

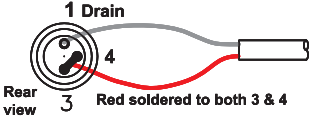
AutoAnchor Sensor Wiring - Use the Plug In Sensor Connector Cables

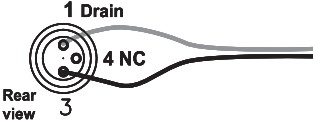
Field Connectors for Plug - Used if the sensor or console does not have plugs.

<p>Grey 3 Wire AutoAnchor Sensor (#9067)</p> <p>Suitable for Chain only or Combined Rope and Chain Rods</p>	<p>Female Field Connector (#9509)</p> 		<p>Grey 3 Wire AutoAnchor Sensor (#9067)</p>
<p>Black 2 Wire (#9008) or White 2 Wire (#9078) AutoAnchor Sensor</p>	<p>Female Field Connector (#9509)</p> 		<p>Black 2 Wire (#9008) or White 2 Wire (#9078) AutoAnchor Sensor</p>
<p>Reed Switch Sensor</p>	<p>Female Field Connector (#9509)</p> 		<p>Reed Switch Sensor</p>

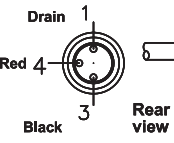
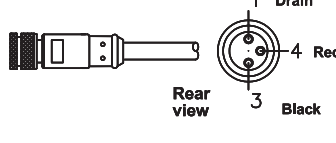
Sensor Cable Joins

<p>Male Field Connector #9507</p> 	<p>Female Field Connector #9509</p> 	<p>Exploded Field Connector Assembly Example</p> 
---	--	--

Cable Connections without Plugs

If the AutoAnchor plug in connectors are not used the cable joins must be solder spliced and sealed in heat shrink tubing. The entire splice must be water proof. Sensor cable must be Beldon 8501 (24 AWG) or equivalent.

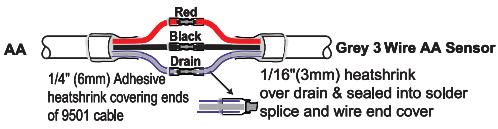
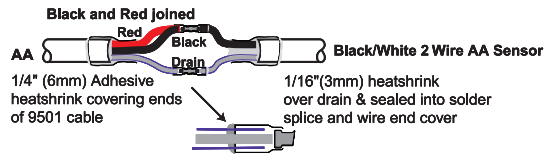
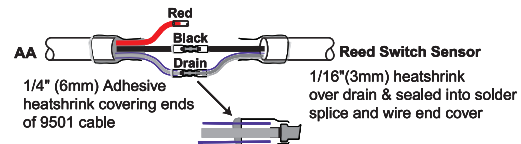
<p>Sensor Cable Splice Using the Grey 3 Wire AutoAnchor Sensor (#9067)</p> <p>Ensure all wires are matched and connected including the screen/drain wire. All connections must be made for the unit to operate.</p>	
<p>Sensor Cable Splice Using the Black (#9008) or White (#9078) AutoAnchor Sensor</p>	
<p>Sensor Cable Splice Using a Reed Switch Sensor</p> <p>When connecting the reed switch sensor to the AA, the red wire is not connected.</p>	

AA560V2.1: CHAIN ONLY WIRING FOR AA560 SYSTEM

Refer to installation instructions for magnet and sensor fitting



Match these wires colour for colour

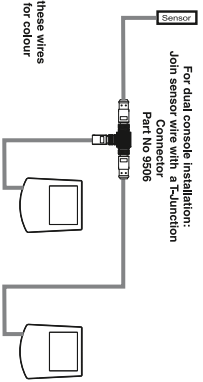

IMPORTANT: All windlass controls must be wired in parallel

Isolating Switch required if windlass is not readily accessible from the helm.

+12/24V DC Common Supply for all windlass controls. Not to be supplied from the motor positive near the windlass.

Two terminal motor

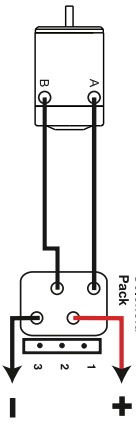

Refer to windlass manufacturer for motor wiring

Three terminal motor

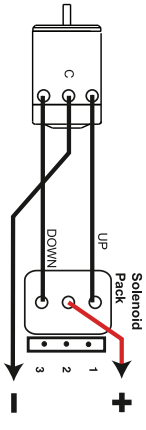

Refer to windlass manufacturer for motor wiring

Four terminal motor

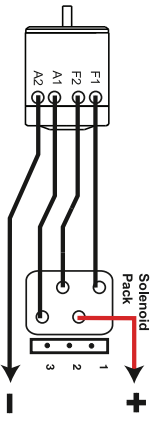

Refer to windlass manufacturer for motor wiring

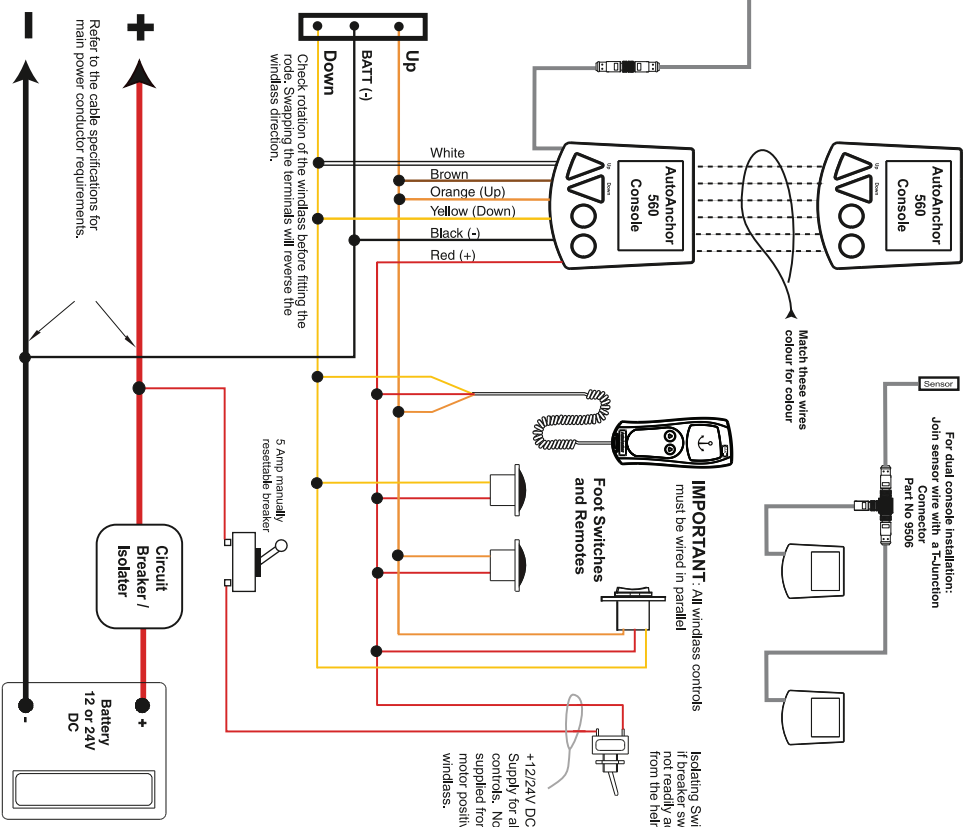

Refer to the cable specifications for main power conductor requirements.

INSTALLATIONS MUST BE CARRIED OUT IN ACCORDANCE WITH USCG, ABYC, NIMA and IAEA REQUIREMENTS

WARNING: Power must be disconnected during installation and when making any changes to wiring after installation

AA560V2.3: AC, HYDRAULIC AND PLC WIRING FOR AA560 SYSTEM

Refer to installation instructions for magnet and sensor fitting

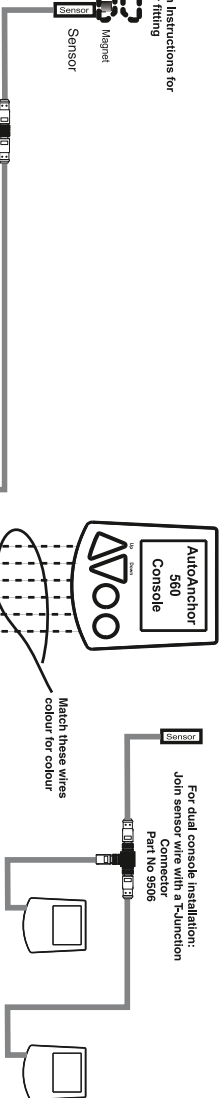
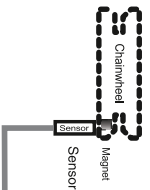

Example windlass drives

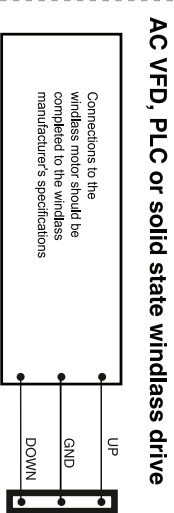
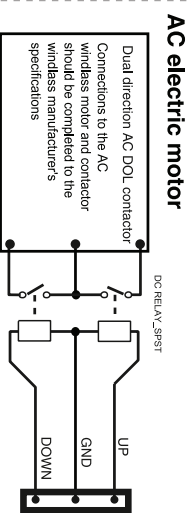
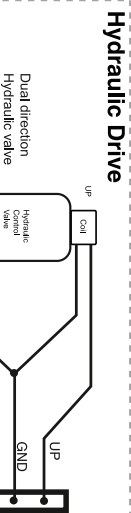

Check rotation of the windlass before fitting the rode. Swapping the terminals will reverse the windlass direction.

Note: When connecting to solid state switching or other low current windlass drives eg. PLC or AC variable frequency, a dummy resistor lead (Part #9515) may be required to provide sufficient loading and to meet EMC and safety considerations. The resistor pack should be installed close to the windlass control not near the AA560. Refer to page 12 in the Owner's Manual.

IMPORTANT: All windlass controls must be wired in parallel

Isolating Switch required if breaker switch is not readily accessible from the helm

+12/24V DC
Common supply for all windlass controls. Not to be supplied from the motor positive near the windlass.

WARNING: Power must be disconnected during installation and when making any changes to wiring after installation

INSTALLATIONS MUST BE CARRIED OUT IN ACCORDANCE WITH USCG, ABYC, NMMA and BMECA REQUIREMENTS

ALL CHAIN WIRING FOR MULTIPLE AA PRODUCTS 150 | 560

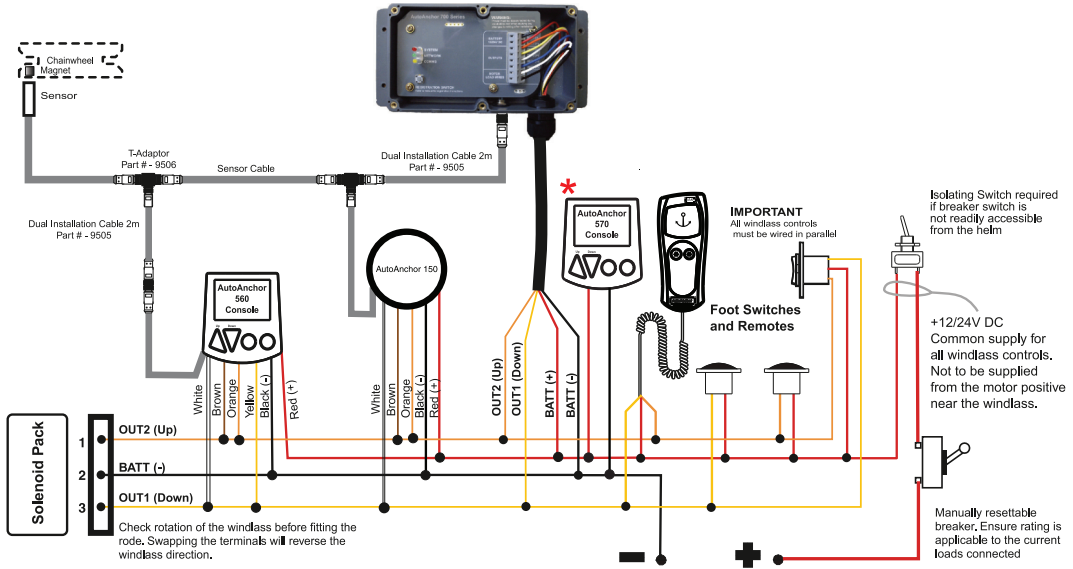

ROPE AND CHAIN WIRING FOR MULTIPLE AA PRODUCTS 150 | 560

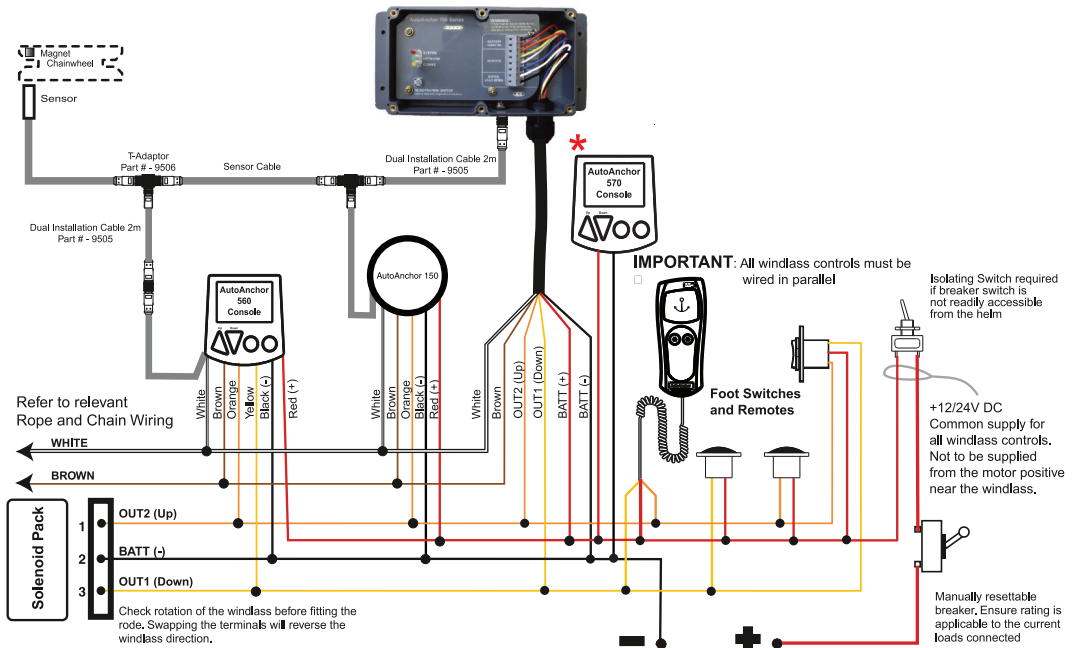

WARNING: Power must be disconnected during installation and when making any changes to wiring after installation

INSTALLATIONS MUST BE CARRIED OUT IN ACCORDANCE WITH USCG, ABYC, NMMA and BMEA REQUIREMENTS

The *AA570 can also be connected directly into any 12v or 24v protected power supply

WD-AA150/560

Auto Anchor 500 Series Console Drilling Template

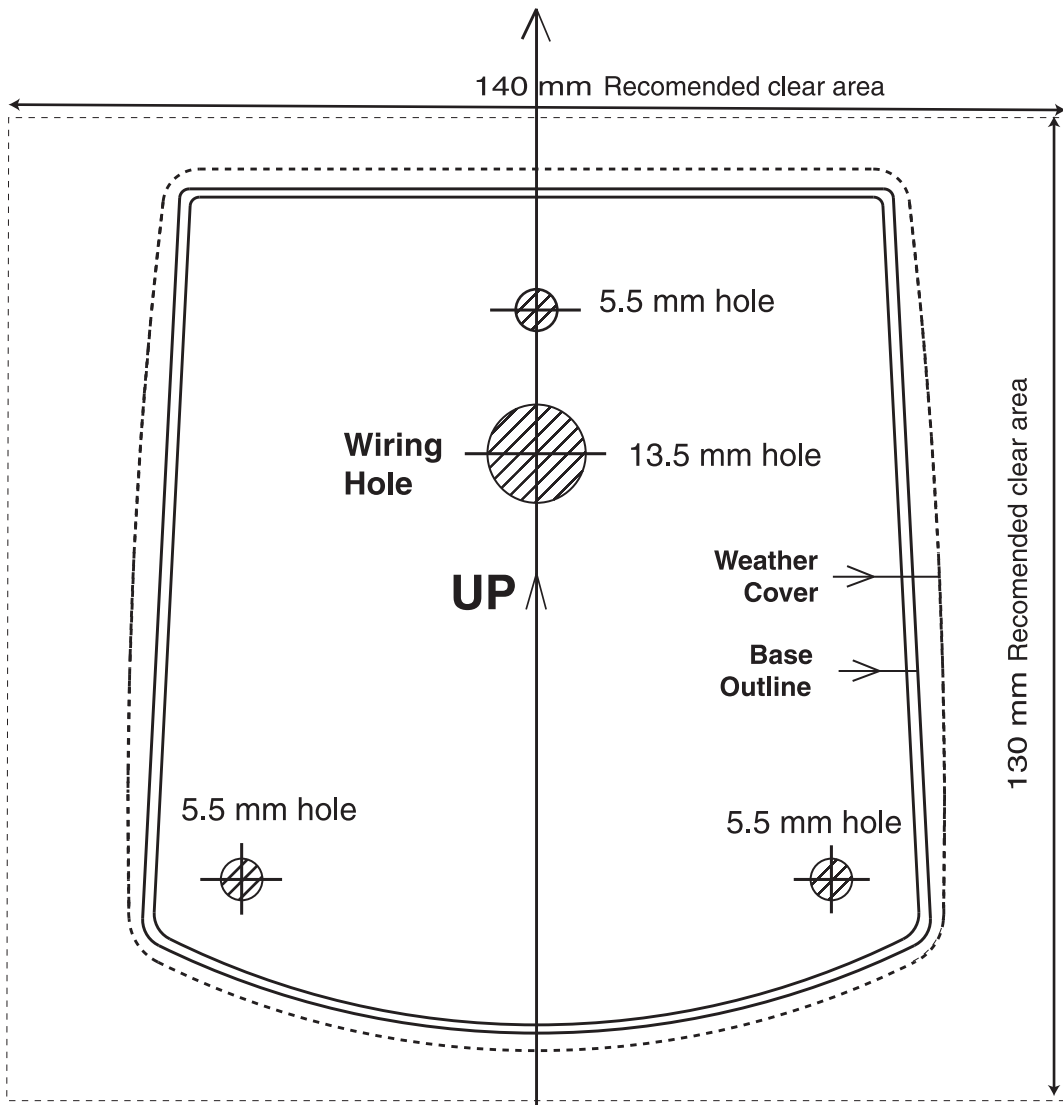

Notes:

- * Mount on a flat surface
- * Do not use sealer or glue
- * Hand tighten mounting bolts
- * Do not use metal studs

AutoAnchor Product Warranty

Kiwi Yachting Consultants Limited
PO Box 90114
Victoria St West
Auckland 1142
New Zealand

Phone: +64 09 360 0300
Fax: +64 9 360 0302
Australia: 1800 201 853
Email: sales@autoanchor.co.nz
Web: www.autoanchor.co.nz



**A Kiwi Yachting
Company**

KYC Limited warrants all AutoAnchor products against defects in materials and workmanship for 3 years under normal use.

Provided KYC receives notice of such defects during the warranty period KYC will, at its option, either repair or replace products that prove to be defective.

Determination of the suitability of the product for the use contemplated by the buyer is the sole responsibility of the buyer and KYC shall have no responsibility in connection with such suitability.

Warranty does not apply to defects resulting from:
Improper or inadequate installation, maintenance or calibration;
Unauthorised modification of the product;
Misuse of the product;
Operation outside the published specifications for the product;
Corrosion, wear and tear.

KYC shall not be responsible for shipping charges or installation labour associated with any warranty claims.

KYC shall not be liable for consequential damages to any vessel, equipment or other property or person due to use or installation of an AutoAnchor product.

The warranty period applies from the date of purchase. Proof of purchase is required when claiming under warranty.

Any statements contained on KYC's website or in its marketing literature shall not be deemed to widen KYC's obligations under this warranty.

To make a claim under warranty contact KYC or your supplier.

To be eligible for warranty protection please complete the warranty form below and post to the address above.

Purchaser

Name:	
Telephone:	Facsimile:
Email:	

Address

Supplier/Dealer

Name:	
Telephone:	Facsimile:
Email:	

Address

Auto Anchor Model

Serial Number

Date of purchase	Boat Type
Name of Boat:	L.O.A
Built by	

Windlass Model

INDEX

Anchoring		Magnet	3, 6-8
Automatic	22-23	Fit	3, 6-8
Safety Override	23	Gap	3, 6-8
Manual	22	Installing Horizontal Windlass	8-9
Back Light	24	Installing Vertical Windlass	6-7
Buttons	13, 20	Polarity	3
Lock	14, 20	Seal	3
Using the Buttons	13	Size	3, 6-8
Cable	4, 11	Menu Overview	13
Cable Specifications	11	Motor Driven Sensors	18
Lengths	4	Motor Load Wires	12
Calculating chain per turn	16-17	Multiple AA Installations	10, 12
Chain Only	16	Operation	20-24
Rope and Chain	17	Anchoring	22-23
Calculating rope per turn	17	Automatic	22-23
Chain Coiling	15-19	Manual	22
Windlass Set Up	15-19	Counter Only	15
Chain Only Set Up	16	Other Settings	24
Check Logs	24	PLC - low current windlass drive	12
Clear to Zero	24	Plug and play sensor tuning	21
Connecting to Low Current Drive	12	Plug & Play Sensor	4
Console		Power Supply	10
Buttons	13, 20	Voltage Levels	11
Installation	10	Reed Switch Sensor	5
Control Swap	18	Resetting to Factory Defaults	14
Counter Only	15	Resetting the sensor	24
Deploying the Anchor	22, 23	Retrieving the Anchor	22, 23
Diagnostic Information	28-29	Rode	15-19
Docking Distance Set Up	15	Chain only	15-16
Docking Alarm	22	Calculating chain per turn	16
Drum Winches	9, 19	Set Up	15
Dual Installation	5	To Enter Chain per Turn	16
Electromagnetic Compatibility	2	Rope and Chain	16-18
Factory Defaults	14	Calculating chain per turn	17
Field Connectors	4	Calculating rope per turn	17
Gender Changer	4	Set Up	16
General Set Up	14	To Enter Chain per Turn	17
Horizontal Windlass	8-9	To Enter Rope per Turn	18
Magnet Installation	8-9	Rope and Chain Set Up	17
Sensor Installation	8-9	Safety Override	23
Important Information	1	Sensor	3-9
Installation	3-12	Connection	3-9
Dual Installation	5	Fitting	4-9
Drum Winches	9	Gap	6-8
Horizontal Windlass	8-9	Information	28
Magnet and Sensor	3-9	Installation	3, 6-9
Multiple AA Installations	10, 12	Plug & Play	4
Vertical Windlass	6-7	Position	4-9
Keys	13, 20	Reed Switch	5
Lock	14, 20	Reset	24
Using the Keys	13	Set Up	18
Language	14	Tuning	5, 21
Lock	14, 20		
Low Current Drive	12		
Maintenance	25		

Set Up	13
Backlight	24
Check Logs	24
Docking Distance	15
Drum Winch	19
General	14
Key Beep	14
Menu Overview	13
Rode	15
Sensor	18
Units	14
Use Preset	17
Windlass	15-19
Specifications Technical	
Swap Control	18
Technical Specifications	2
Technician Diagnostics	28-29
Testing	21
Troubleshooting	25-29
Units Set	14
Use Preset	17
User Precautions	1, 21
Vertical Windlass	6-7
Magnet Installation	6-7
Sensor Installation	6-7
Voltage	11
Windlass	
Horizontal	8-9
Magnet Installation	8-9
Sensor Installation	8-9
Installation	6-9
Set Up for Chain Counting	15-19
Vertical	6-7
Magnet Installation	6-7
Sensor Installation	6-7
Wiring	11
AC Variable Frequency Drive	12
Low Current Windlass Drive	12
Motor Load Wires	12
Multiple AA Installation	12
PLC	12
Wiring Diagrams	34-38
Template	39



**A Kiwi Yachting
Company**

The AutoAnchor is designed and manufactured by:

Kiwi Yachting Consultants Ltd
PO Box 90114, Auckland Mail Centre, Auckland, New Zealand
Ph: +64 9 360 0300 Email: support@autoanchor.co.nz

AutoAnchor is a trademark of Kiwi Yachting Consultants Limited Copyright © 2013,
Kiwi Yachting Consultants Limited, New Zealand



AA560OWN b